

PHILCO 

iluminación

ILUMINA TU VIDA CADA DÍA

**CATÁLOGO
2020**

PHILCO 

iluminación

ILUMINA TU VIDA CADA DÍA

**CATÁLOGO
2020**



Comprometidos

CONTIGO



LÁMPARAS
DE LED



Pág. 7

LÁMPARAS
FLUORESCENTES



Pág. 23

LÁMPARAS
DECORATIVAS



Pág. 28

LUMINARIOS
DECORATIVOS



Pág. 35

LUMINARIOS
COMERCIALES



Pág. 46

LUMINARIOS
PARA INTERIOR



Pág. 50

LUMINARIOS
DE EMERGENCIA



Pág. 65

LUMINARIOS
DE MESA



Pág. 69

PLACAS Y MECANISMOS



Pág. 77

 **INTERIOR**

The text 'INTERIOR' is in a bold, blue, sans-serif font. To its left is a blue icon of a house with a lowercase letter 'i' inside a square, representing an interior or information symbol.

LUMINARIOS
PARA EXTERIOR



Pág. 82

TIRAS DE LED



Pág. 114

LÁMPARAS
ALTA INTESIDAD DE DESCARGA HID



Pág. 121

PERFILES
DE ALUMINIO



Pág. 123

 **EXTERIOR**

 **INTERIOR**

LÍNEA **Brilla**
Max

Pág. 127

 **EXTERIOR**

 **INTERIOR**

GLOSARIO

Pág. 137





Lámparas
LED

Ahorro de energía y
rápido retorno de inversión.

Bulbos
Filamentos
Velas
MR16
PIN
PAR
Lámparas Especiales
Altas Potencias
Tubular
Circular

BULBOS LED



4W

•51652 •51528

◀ 6 500 K
◀ 3 000 K

4.5 x 7.4 cm



•350 lm
•340 lm



Atenuable

9W

•57066 •57065

◀ 6 500 K
◀ 3 000 K

6 x 10.8 cm



800 lm



127 V



25 000 h



Cumple con
Dictámen Técnico
para Hipoteca Verde

10W

•51603 •51939

◀ 6 500 K
◀ 3 000 K

6 x 10.8 cm



800 lm

12W

•51710 •51653

◀ 6 500 K
◀ 3 000 K

6 x 11.8 cm



•1 200 lm
•1 050 lm

15W

•51654 •51655

◀ 6 500 K
◀ 3 000 K

6 x 11.8 cm



•1 500 lm
•1 350 lm

18W

•51912

◀ 6 500 K

8 x 16 cm



1 710 lm



100-240V



200°



SMD



E26



30 000 h



>80

FILAMENTOS

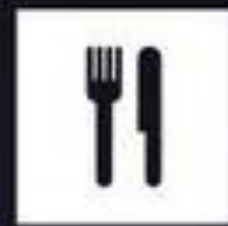

4W

•51175



5.8 x 10.3 cm



5W

•57048



6 x 10 cm

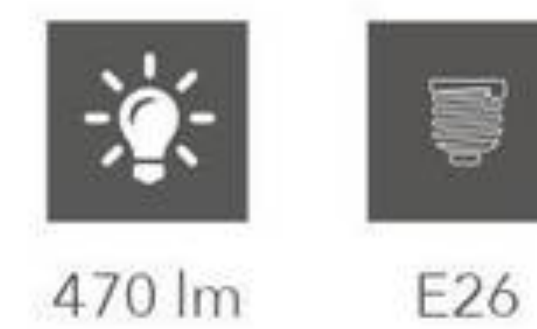

4W

•57049



3.5 x 9.6 cm



CRISTAL

4W

•51650



3 x 9.1 cm



4W

•57169



3.5 x 9.6 cm



4W

•57050



4.6 x 7.6 cm

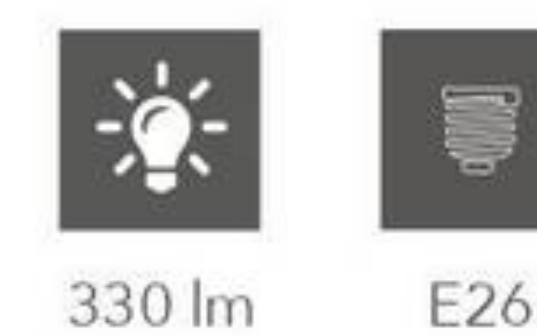

VELAS



ACABADO TRANSPARENTE

4W

•57021 •51463

3.7 x 10.8 cm

350 lm

200°

E12

4W

•51181

3.7 x 10.8 cm

300 lm

150°

E14

GLOBOS ACABADO TRANSPARENTE

4W

•51461 •51166

4.4 x 7.3 cm

300 lm

E26

6W

•51167

4.5 x 8 cm

470 lm

E14

240°

ACABADO OPALINO

4W

•51460 •51165

3.7 x 10.4 cm

300 lm

E26

4W

•51462

3.7 x 10.8 cm

300 lm

E12

4W

•51164

3.5 x 10.3 cm

250 lm

E14

4W

•57170

3.5 x 10.3 cm

250 lm

E14

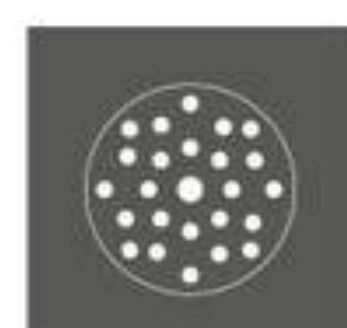

100-240V

200°

SMD

25 000 h

>80

MR16



3W
•51771 •51770

◀ 6 500 K
◀ 3 000 K



5 x 4.5 cm



100-250 V



250 lm



GU5.3

6W
•51774 •51773

◀ 6 500 K
◀ 3 000 K



5 x 4.5 cm



450 lm



GU5.3

6W
•57160 •57179

◀ 6 500 K
◀ 3 000 K



5 x 5.4 cm



450 lm



GU10



100-240V



38°

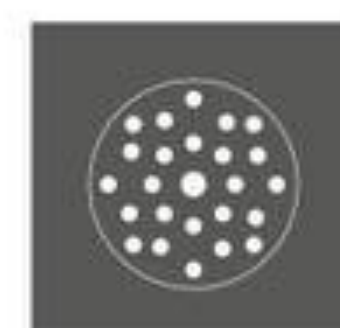

SMD



25 000 h



>80

MR16 ATENUABLES

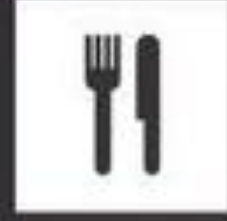

7W

•57162



5 x 4.5 cm



GU5.3

7W

•57161



5 x 4.5 cm



GU5.3

7W

•51163



5 x 5.7 cm



GU10

7W

•57181



5 x 5.7 cm



GU10



120V



500 lm



36°

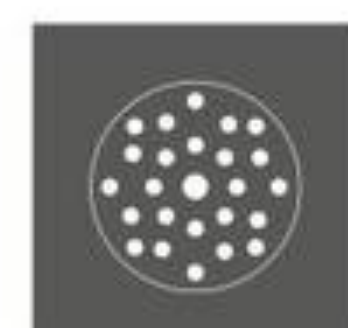

SMD



25 000 h



>80



ATENUABLES

2.5W

•51680



1.6 x 6 cm



270 lm



260°



COB



25 000 h

3W

•51681



1.6 x 6 cm



330 lm

2.5W

•51134



1.6 x 5 cm



200 lm



200°



SMD



15 000 h

4W

•51135



1.6 x 5 cm



300 lm

2.5W

•51636



1.4 x 4.7 cm



270 lm



320°



COB



20 000 h

2.5W

•51679



1.25 x 3.7 cm



270 lm



12 V



260°



COB



G4



25 000 h

2.5W

•51136



1.6 x 4 cm



180 lm



12 V



200°

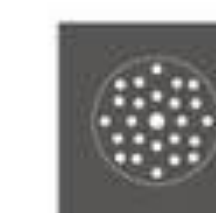

SMD



G4



15 000 h



127 V



G9



>80

PAR



PAR30

12W

•51209



9.5 x 11.5 cm



900 lm



COB



100-240 V



38°

12W

•57052 •57051



9.5 x 11.5 cm



•950 lm
•900 lm

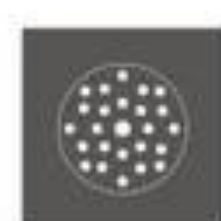

SMD

PAR30 CUELLO CORTO

12W

•51819



9.5 x 9.8 cm



100-277 V



900 lm



SMD



ATENUABLES

PAR20

8W

•51202 •51201



6.3 x 8.1 cm



•500 lm
•450 lm

PAR30

12W

•51204 •51146



9.5 x 11.5 cm



•950 lm
•900 lm

PAR38

16W

•51529 •51514



12.1 x 13 cm



•1 400 lm
•1 300 lm



120 V



38°



COB



E26



25 000 h

PAR LÍNEA ECO

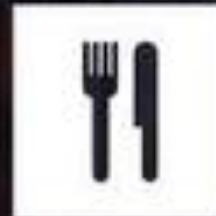

PAR20

8W

•51806 •51805



6.3 x 8.1 cm



•500 lm
•450 lm

PAR30

12W

•51808 •51807



9.5 x 11.5 cm



•900 lm
•850 lm



200°



SMD



25 000 h

PAR38

16W

•51810 •51809

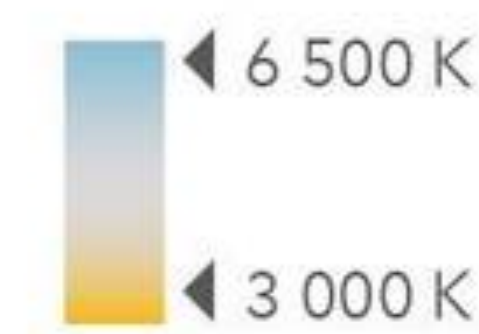

12 x 13 cm



1 400 lm

PL DE LED **360°**

8W

•51213



3.5 x 16.6 cm



8W

•51214



3.5 x 16.6 cm



G24



100-240 V



750 lm



145°



32 000 h



E26



>80

LÁMPARAS ESPECIALES

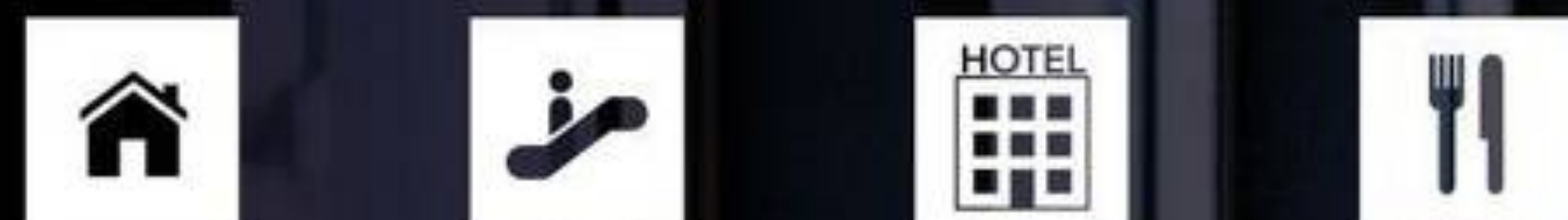

Atenuables

4W

•51858



3.8 x 11.3 cm



360 lm



0,7

7W

•51859



4.3 x 16 cm



700 lm

12W

•51861 •51860



4.3 x 16 cm



•1 300 lm
•1 200 lm



100-120 V



270°



50 000 h



E26



>80



0,9



IP54

LÁMPARA TUBULAR



Atenuable

24W

•51855 •51854



Ø2.9 cm x 1.52 m



•2 980 lm
•2 880 lm



120 V



270°



50 000 h



>80



0,9



IP54

ACCESORIOS PARA LÁMPARA TUBULAR



CONECTOR

51864
1 metro



CONECTOR T

51865

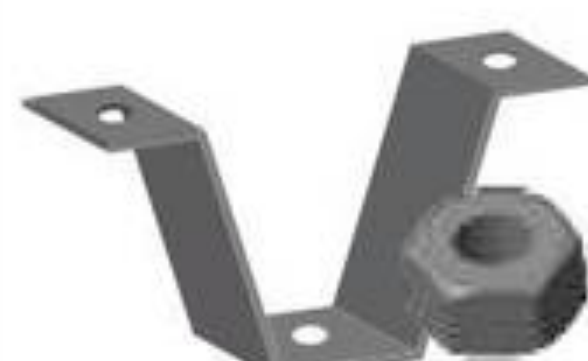

BRACKET

51866

CONSOLA DE CONTROL

4 000W

•51862



14 x 20 cm



•2 980 lm



120 V



50 000 h



IP66



IK10

ALTAS POTENCIAS



40W
•51366
◀ 6 500 K
7.8 x 15.4 cm
4 000 lm
100-277 V 30 000 h

70W
•51144
◀ 6 500 K
8.8 x 16.8 cm
7 100 lm
100-277 V 30 000 h

8 x 15 cm
•51428
•51427
1 800 lm
1 700 lm

10 x 18.5 cm
•57121
2 700 lm

11.8 x 21.3 cm
•51429
3 600 lm

11.8 x 21.3 cm
•51588
4 600 lm

20W
•51428
•51427
3 600 lm

27W
•57121
2 700 lm

40W
•51429
3 600 lm

50W
•51588
4 600 lm

40W 12 x 21.5 cm
•51727
3 600 lm

70W 13.5 x 25 cm
•57116
6 300 lm

90W 14 x 26.8 cm
•57122
9 100 lm

◀ 6 500 K
◀ 3 000 K
110-240 V 25 000 h E39 (40W, 70W, 90W)

Acabado Transparente

50W
•57115
5 190 lm
12 x 21.5 cm

40W
•51616
•57068
3 800 lm
3 600 lm
12 x 21.5 cm
◀ 6 500 K
◀ 3 000 K
110-240 V 25 000 h E39

40W
•51049
◀ 6 500 K
85-265 V 3 600 lm 35 000 h COB

100W
•57126
◀ 6 500 K
11 000 lm 57126

120W
57127
13 100 lm 57127

19x 22 cm
120° 30 000 h

Accesorio para lámpara de 100 W
◀ 90° 57128

Accesorio para lámpara de 120 W
57129 ◀ 90°

TECNOLOGÍA LED 110-240 V 200° E26 SMD IRC >80

LÁMPARAS TUBULARES T8 LED



9W

•57152



60 cm



850 lm

Vidrio transparente



9W

•57153



60 cm



800 lm

Vidrio Opalino



18W

•57154



120 cm



1 700 lm

Vidrio transparente



18W

•57155



120 cm



1 650 lm

Vidrio Opalino



110-240 V



270°



25 000 h



G13



SMD



>80



T8



Conexión
Ambos lados

TUBOS DE LED T8



Vidrio Opalino

10W

•51377

◀ 6 500 K

54.5 cm



⚡ 100-265 V

💡 800 lm

🔧 220°

🕒 12 000 h

Vidrio Transparente

18W

•51478

◀ 6 500 K

120 cm



⚡ 110-240 V

💡 1 800 lm

🔧 200°

🕒 25 000 h

NaNo T8

18W

•51515
•51516
•51595

◀ 6 500 K
◀ 4 100 K
◀ 3 000 K

120 cm



💡 1 900 lm
💡 1 900 lm
💡 1 850 lm

⚡ 100-277 V

🔧 220°

🕒 25 000 h

🔌 G13

🔍 SMD

IRC >75

🌀 T8

⚡ Conexión 1 lado

TECNOLOGÍA LED

SMD

G13

IRC >75

🌀 T8

⚡ Conexión Ambos lados

*Para uso en el luminario 51376

TUBOS PREMIUM T8



25W

120 cm

•51682

◀ 6 500 K

💡 3 100 lm



25W

120 cm

•51683
•57072

◀ 6 500 K
◀ 4 100 K

💡 2 950 lm
💡 2 950 lm

TECNOLOGÍA LED

⚡ 100-277 V

🔧 270°

🕒 25 000 h

🔌 G13

🔍 SMD

IRC >80

🌀 T8

⚡ Conexión Ambos lados

TUBOS T8



Vidrio Transparente y Aluminio

36W

•51880



240 cm



3 100 lm



G13

Vidrio Opalino y Aluminio

36W

•51881



240 cm



3 000 lm



G13

36W

Vidrio Transparente y Aluminio

•51882



240 cm



3 100 lm



FA8

36W

Vidrio Opalino y Aluminio

•51883



240 cm



3 000 lm



FA8

TUBOS DE COLOR

Vidrio Transparente

18W



•57078



•57079



•57080



•57081

120 cm



100-240 V



G13



110-240 V



220°



25 000 h

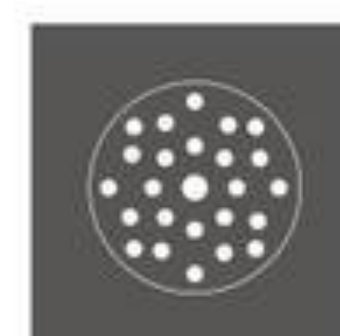

SMD



>80



T8

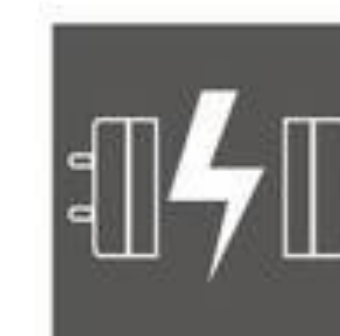

Conexión
Ambos lados

TUBOS DE LED T5



9W

•51744 •51743



54.1 cm



•850 lm
•800 lm



18W

•51746 •51745



114.9 cm



•1 650 lm
•1 600 lm



LED CIRCULAR

20W

•51440



25.8 x 9 cm



1 600 lm

2 Modos de
Instalación

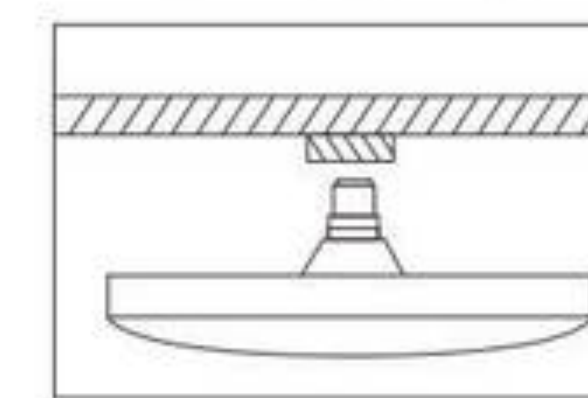

Para sobreponer

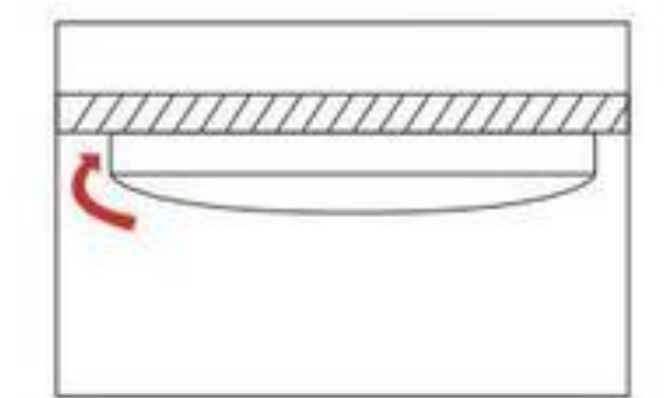

9W

•57182



54.1 cm



850 lm

Vidrio transparente



18W

•57183



114.9 cm



1 650 lm

Vidrio transparente



100-265 V



270°



25 000 h



G5



SMD



>80



T5

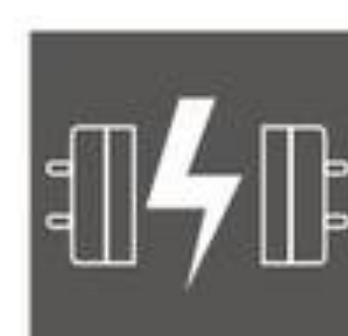

Conexión
Ambos lados



85-265 V



25 000 h



SMD



E26



>80





Lámparas

FLUORESCENTES

Ahorro del 80% de energía que una lámpara incandescente convencional.

Espirales

Tubos

Alta Potencia

ESPIRAL AUTOBALASTRADA (CFL)



9W
•50868 •50869
◀ 6 500 K
▶ 2 700 K
5 x 8.6 cm
450 lm



23W
•57123
◀ 6 500 K
5.4 x 13.5 cm
1 400 lm



10 000 h T2

20W
•50871
◀ 6 500 K
4 x 13.1 cm
1 200 lm



25W
•50236
◀ 6 500 K
5.3 x 13.6 cm
1 550 lm



30W
•50251
◀ 6 500 K
5.3 x 14.9 cm
1 800 lm



8 000 h T3

127 V E26 >80 IRC

TUBOS FLUORESCENTES



TUBOS T5

14W

•50862 •50864



56.3 cm



1 200 lm



28W

•50863 •50854



116.3 cm



2 600 lm



T5



G5

54W

•50935 •50853



116.3 cm



4 860 lm



TUBO T8

32W

•50866 •50852



121.4 cm



2 700 lm



T8



G13



18 000 h



>80

ALTA POTENCIA HALF SPIRAL



45W

- 50221 • 50215
- 50851

◀ 6 500 K

7.3 x 21.8 cm

127 V (50221) (50215)	220 V (50851)	2 900 lm	E26 (50221)	E39 (50215) (50851)

65W

- 50222 • 50202
- 50254

◀ 6 500 K

7.3 x 26.8 cm

127 V (50222) (50202)	220 V (50254)	4 100 lm	E26 (50222)	E39 (50202) (50254)

85W

- 50203 • 50204
- 50205

◀ 6 500 K

7.3 x 30 cm

127 V (50203) (50204)	220 V (50205)	5 950 lm	E26 (50203)	E39 (50204) (50205)

105W

- 50223 • 51445

◀ 6 500 K

8.8 x 30.5 cm

127 V (50223)	220 V (51445)	7 350 lm	E26 (50223)	E39 (51445)



10 000 h



>80



T5





Lámparas

DECORATIVAS

Terminados en color dorado, artesanales o mate para cualquier ocasión.

LED Vintage

Artesanales

Incandescentes
Vintage

Línea MIPOW

Bulbos de Color

Series Navideñas



VINTAGE LED



2W

•51704



9.5 X 13.8 cm



G95

2W

•51705



6.8 X 16.2 cm



ST64

2W

•51705-1



6.8 X 16.2 cm



ST64

127 V
 150 lm
 15 000 h
 E26

5W

•57029

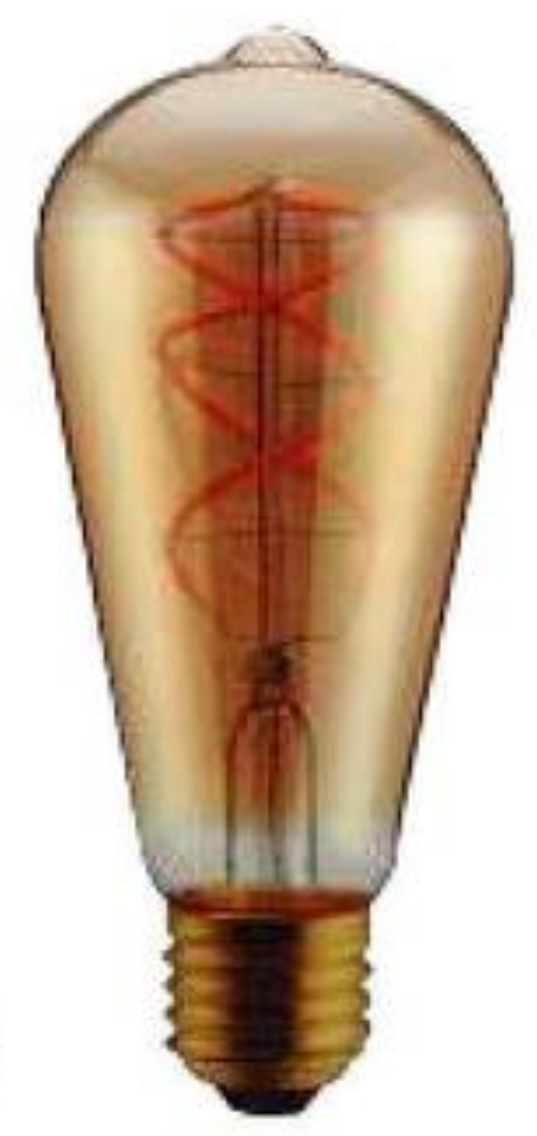

6.4 X 14.4 cm



260 lm



ST64

5W

•57030



9.5 X 13.5 cm



260 lm



G95

120 V
 20 000 h
 E26

4W

•57032



8.5 X 15.5 cm



280 lm



360°

22.5W

•57032



ESPACIO ENTRE LÁMPARAS
98cm



CONECTA HASTA 5 SETS



120 V



2 250 lm



25 000 h



IP65

*Incluye 15 Lámparas decorativas de LED de 1.5 W Base E26

ARTESANALES LED



6W

51708



13 X 18 cm



150 lm



G130

6W

51709



12.8 X 17.8 cm



150 lm



G128

4W

51706



20 X 28 cm



350 lm



G200

4W

51707



20 X 28 cm



250 lm



G200



85-265 V



20 000 h



E26

Incluyen luminario para suspender vintage

INCANDESCENTES VINTAGE

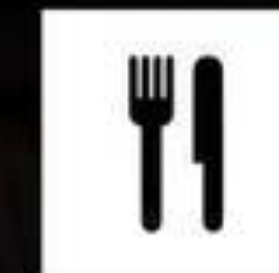
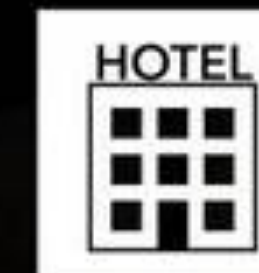

40W

• 51124



4.5 X 8.5 cm



ST55

40W

• 51116



6.5 X 13 cm



A19

40W

• 51125



8 X 11.7 cm



G80

40W

• 51425



9.5 X 13.9 cm



G95

40W

• 51426



6.8 X 16.2 cm



ST64

40W

• 51364



2.8 X 13.9 cm



T28



100-277 V



120 lm



2 500 h



E26



>90

MIPOL



5W

51413

6 X 10 cm



280 lm



5W

51414

6 X 10 cm



280 lm



10W

51416

7.1 X 11.7 cm



700 lm



5W

51417

8 X 13.8 cm



260 lm



Con
Altavoz



RGB



100-240 V



E26



Bluetooth® V4.0



10 m Alcance de Bluetooth

Toma el control
desde la App
PLAYBULB X



Compatible con
Android e IOS

BULBOS DE COLOR *LED*



•51419



•51420



•51421



•51422



○51423



•51424



4.5 X 6.9 cm

1W



127 V



220°



15 000 h



SMD



E26



G45



0,9

SERIE NAVIDEÑA *LED*

RGB

1.6W

50816



120 V



20 000 h

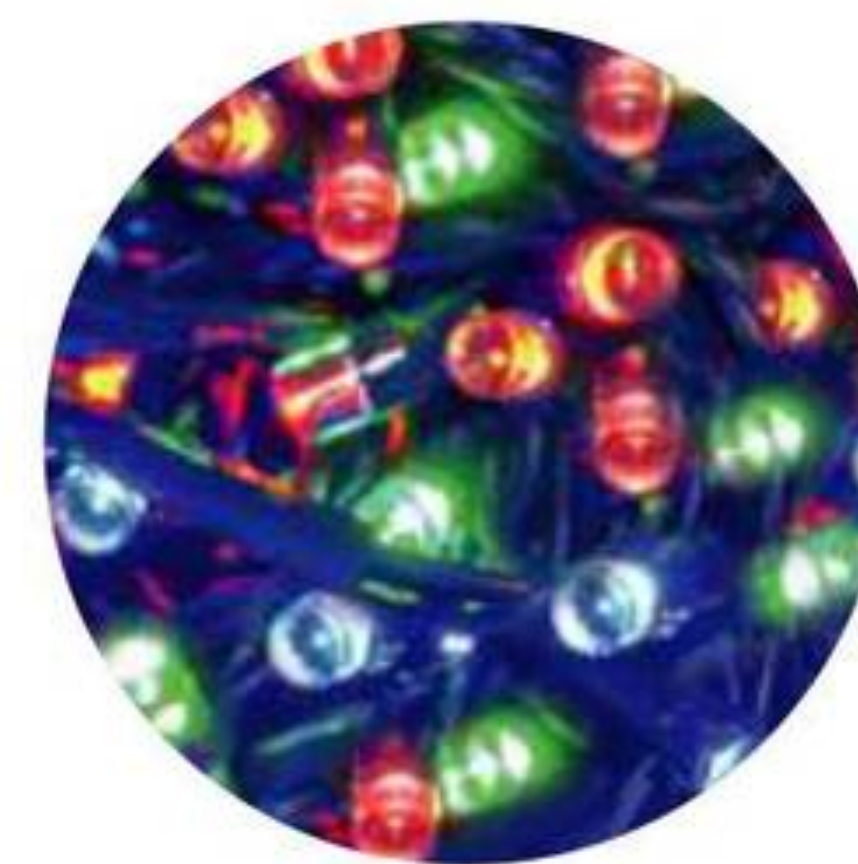

7.75 metros





Luminarios de interior
DECORATIVOS

Diseños que transforman tus espacios.

Para Suspende de LED
Para Suspende
Para Sobreponer
Para Sobrponer LED
Lámparas de Vanidad

PARA SUSPENDER DE *LED*



28W

•51731 •51730



14 x 122 cm



Óptica opalina
Incluye 1.5m de kit de suspensión



•2 450 lm
•2 300 lm

30W

•51253



86 cm



Aluminio y acrílico



90-260 V



1 900 lm



30 000 h

24W

•51492



22 X 3.5 cm

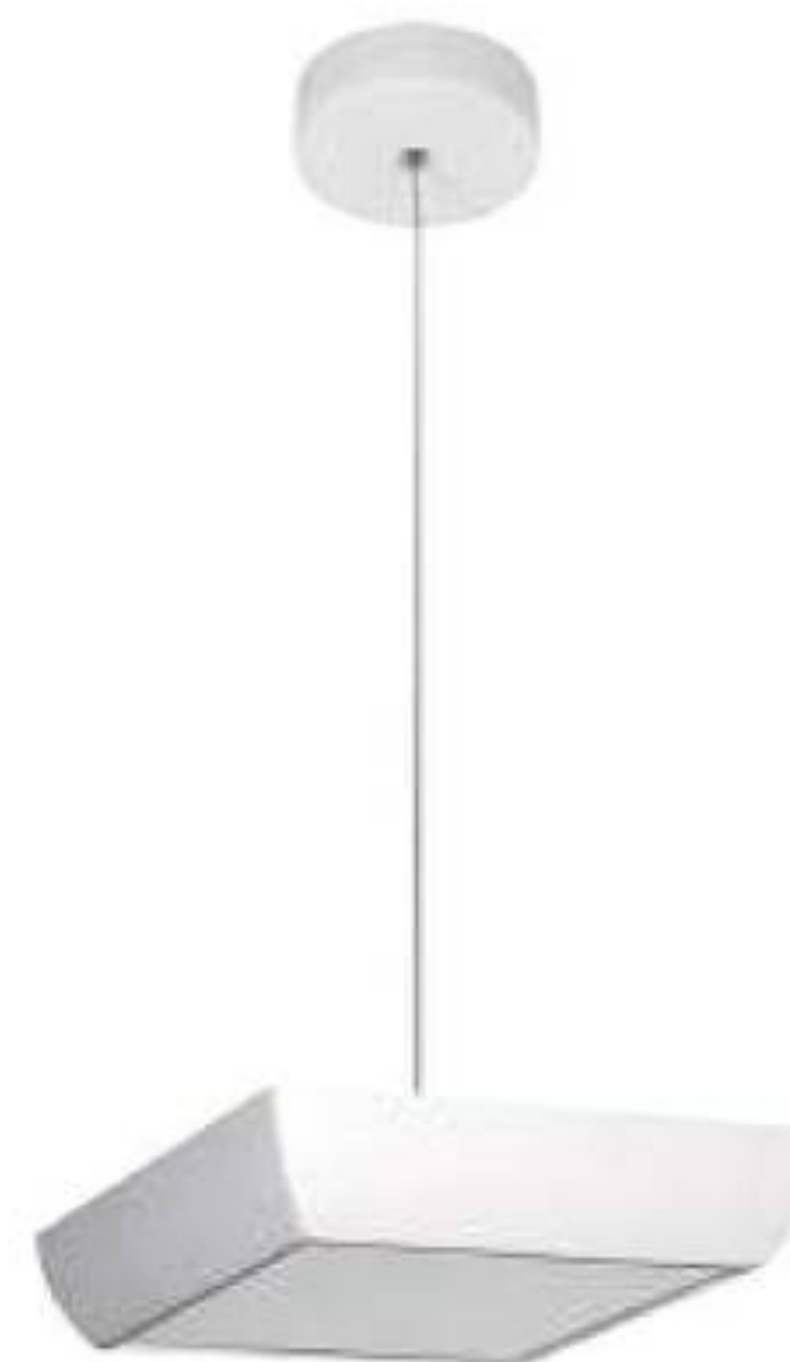

2 000 lm



100-240 V



35 000 h

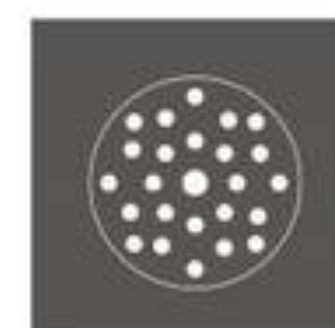

SMD



>80



>0,9

PARA SUSPENDER CON FUENTE DE LUZ INTERCAMBIABLE

 LÁMPARA
NO INCLUIDA

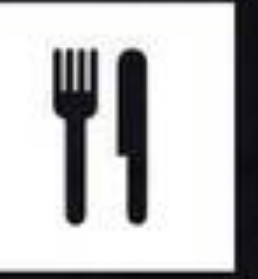

1 Base E26

PARA SUSPENDER CON FUENTE DE LUZ INTERCAMBIABLE

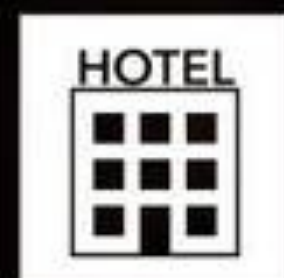

LÁMPARA
NO INCLUIDA



51781

30 x 24 cm



51782

16.5 x 19 cm



51783

30 x 15 cm



51784

30 x 23 cm



51785

25 x 16 cm



51667

20 x 120 cm



51668

20 x 120 cm



G9



51669

10 x 120 cm



G9



51673

5.4 x 8.8 cm



51674

5 x 7.5 cm



51675

4.2 x 6.3 cm



1 Base E26

PARA SUSPENDER CON FUENTE DE LUZ INTERCAMBIABLE

 LÁMPARA
NO INCLUIDA

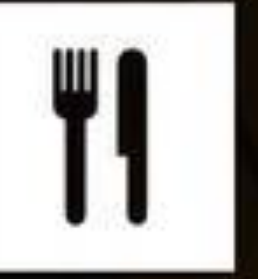
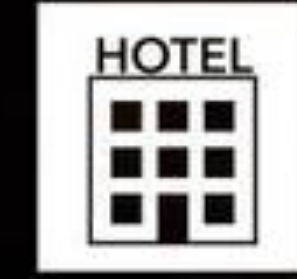

3 Bases
E26



GU10



GU10



1 Base E26

PARA SUSPENDER CON FUENTE DE LUZ INTERCAMBIABLE



LÁMPARA
NO INCLUIDA

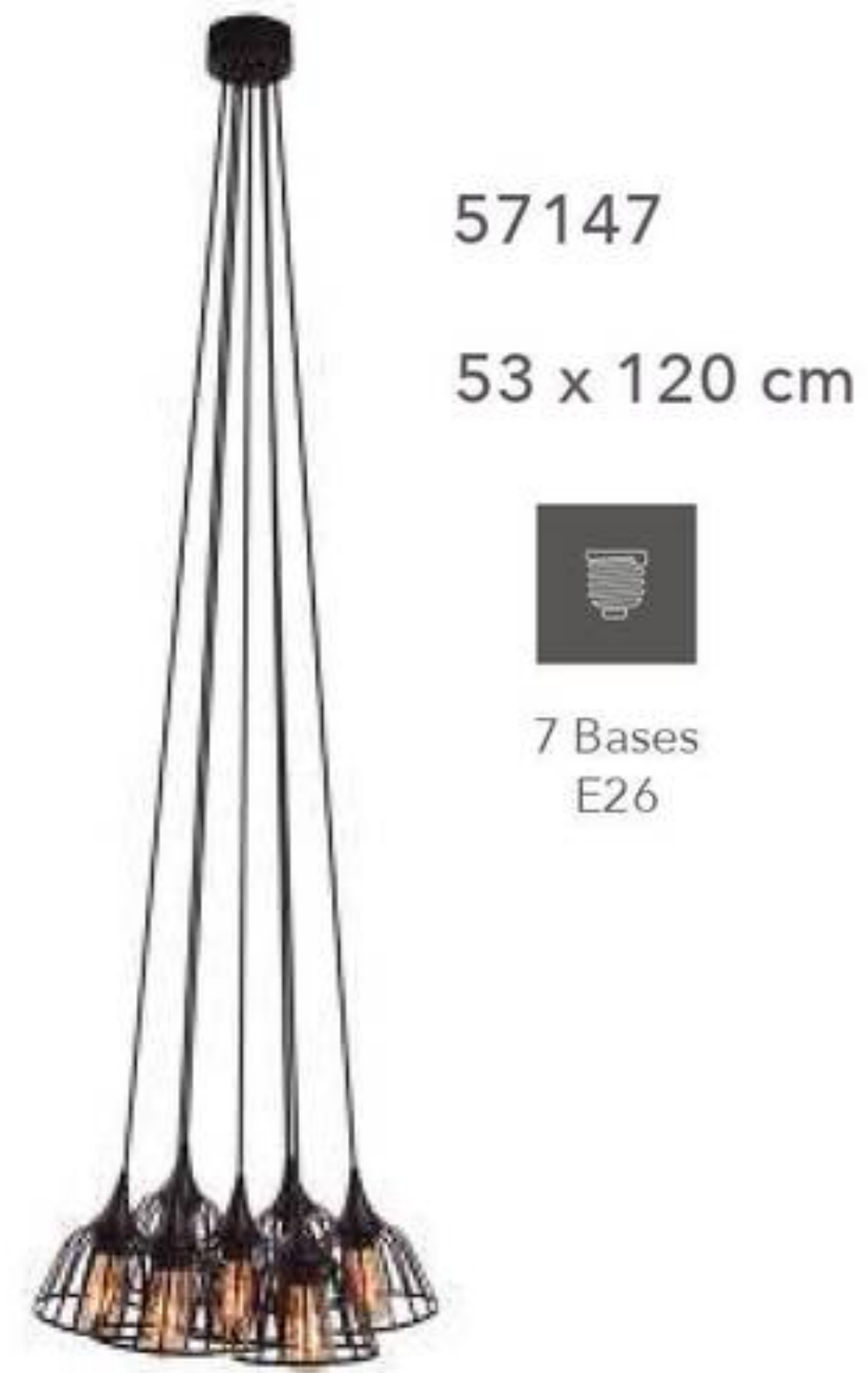

PARA SOBREPONER *LED*



12W

•51498



33 x 16 cm



1 050 lm

16W

•51499



71 x 19 cm



1 400 lm

16W

•51500



28 x 12 cm



1 400 lm

16W

•51502



61 x 19 cm



1 350 lm

Atenuable
por pasos

35W

•51496



62 x 16 cm



1 600 lm

30W

•51254



42 x 16 cm



1 500 lm



30 000 h



90-260 V



35 000 h



SMD



>80

PARA SOBREPONER CON FUENTE DE LUZ INTERCAMBIABLE

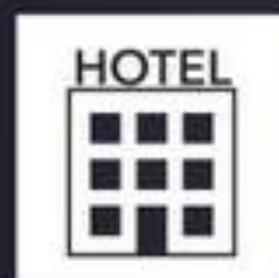

 LÁMPARA
NO INCLUIDA



51822
3 Bases

18 x 16.5 cm



E12



51821
3 Bases

41 x 10 x 19 cm



E12



51823
4 Bases

71 x 10 x 19 cm



E12



51897
4 Bases

82.5 x 12 x 15 cm



GU10

VANIDAD LED

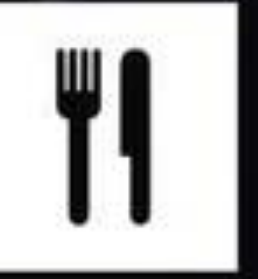

22W

•51632



60 x 80 cm



Atenuable
Encendido al tacto



100-240 V



1 000 lm



25 000 h



IP44

12W

•57125



20 x 9 cm



100-240 V



950 lm



200°



25 000 h

10W

•51523 •51522



52.5 x 13 cm



100-277 V



700 lm



50 000 h

3W

•51724



9 x 13.5 cm



300 lm

4W

•51501



13 x 7.5 cm



320 lm



90-260 V



35 000 h

TECNOLOGÍA
LED



SMD

IRC

>80

VANIDAD LED

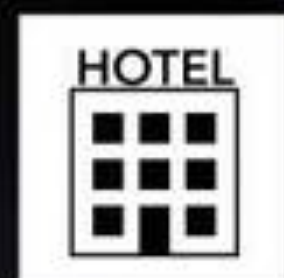

51820
1 Base

13 x 16.5 cm



E12

 **LÁMPARA
NO INCLUIDA**

1W

• 51286



320 lm



◀ 3 000 K



26 x 32 x 17.5 cm

 **LÁMPARA
NO INCLUIDA**



E26





Luminarios

COMERCIALES

Spots para riel de 3 vías

Riel de 3 vías y Conectores

AR111 LED

Luminarios para empotrar

SPOTS PARA RIEL DE 3 VÍAS LED



10W

•51507



12.3 x 18.3 x 9.05 cm



800 lm 38°

30W

•51728 •51508



9.5 x 21.5 x 24.5 cm



2 500 lm 24°
2 400 lm

10W

•51725



12.3 x 18.3 x 9.05 cm



800 lm 38°

30W

•51726



9.5 x 21.5 x 24.5 cm



2 400 lm 24°

TECNOLOGÍA LED



100-240 V



25 000 h



COB

IRC

80

HPF

0,9

SPOT CON FUENTE DE LUZ INTERCAMBIABLE



12 x 22 cm



51815
Blanco



51816
Negro
12 x 22 cm

20W

•51627



3.45 x 13.4 x 17 cm

20W

•51628



3.45 x 13.4 x 17 cm

TECNOLOGÍA LED



100-277 V



24°



30 000 h

IRC

>80



SMD

HPF

0,9



E26

Recomendado para lámpara PAR 30

SPOTS PARA RIEL DE 3 VÍAS LED



10W

•51507



12.3 x 18.3 x 9.05 cm



800 lm 38°

30W

•51728 •51508



9.5 x 21.5 x 24.5 cm



2 500 lm 24°
2 400 lm

10W

•51725



12.3 x 18.3 x 9.05 cm



800 lm 38°

30W

•51726



9.5 x 21.5 x 24.5 cm



2 400 lm 24°

TECNOLOGÍA LED



100-240 V



25 000 h



COB

IRC

80

HPF

0,9

SPOT CON FUENTE DE LUZ INTERCAMBIABLE



LÁMPARA NO INCLUIDA

12 x 22 cm



51815
Blanco



51816
Negro
12 x 22 cm

20W

•51627



3.45 x 13.4 x 17 cm

20W

•51628



3.45 x 13.4 x 17 cm

TECNOLOGÍA LED



100-277 V



24°



30 000 h

IRC

>80



SMD

HPF

0,9



E26

Recomendado para lámpara PAR 30





Luminarios para ***INTERIORES***

Ideal para óptimos lugares de trabajo

Downlights

Alta Potencia
Slim LED
Con Bracket Ajustable
Para empotrar
Fuente de Luz Dirigible

Panel de LED Interconectables De Sujeción

LED
Fuente de luz
intercambiable

DOWNLIGHTS ALTA POTENCIA LED



12W

● 51907 ● 51906

◀ 4 100 K
◀ 3 000 K

9.7 x 7.1 cm



● 970 lm
● 960 lm



20W

● 51909 ● 51908

◀ 4 100 K
◀ 3 000 K

13 x 8.4 cm



● 1 700 lm
● 1 600 lm



Dirigibles

30W

● 51900 ● 51899

◀ 4 100 K
◀ 3 000 K

16.5 x 6.5 cm



● 2 500 lm
● 2 400 lm



40°



40W

● 51902 ● 51901

◀ 4 100 K
◀ 3 000 K

21 x 6.5 cm



● 3 300 lm
● 3 200 lm



50W

● 51905 ● 51904
● 51903

◀ 6 500 K
◀ 4 100 K
◀ 3 000 K

23 x 11 cm



● 4 200 lm
● 4 100 lm
● 4 000 lm



100-277 V



60°



35 000 h



COB



>80



>0,9

DOWNLIGHTS SLIM LED

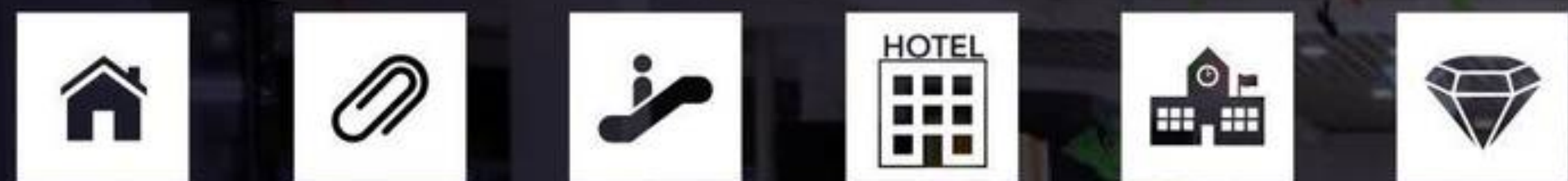

6W

•51997 •51072



1.3 x 12 cm



•375 lm
•360 lm

12W

•51998 •51074



1.3 x 17 cm



•850 lm
•800 lm

15W

•57024 •51368



1.3 x 19 cm



•1 100 lm
•850 lm

18W

•51077 •51076



1.3 x 22.5 cm



•1 100 lm
•1 050 lm

24W

•51371 •51370



1.3 x 29.8 cm



•1 400 lm
•1 350 lm



100-240 V



120°



25 000 h



SMD



>70

DOWNLIGHTS SLIM *LED*



12W

•57010 •51323



17 x 17 x 1.3 cm



•800 lm
•750 lm

18W

•57011 •51325

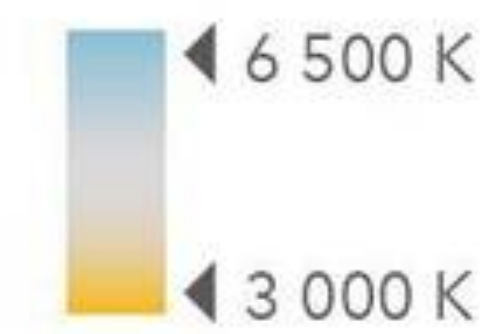

22.5 x 2.5 x 1.3 cm



•1 300 lm
•1 200 lm

18W

•51257



19.2 x 19.2 x 2.4 cm



1 400 lm



30 000 h



75

Con sistema de sujeción

DOWNLIGHTS CON BRACKET AJUSTABLE *LED*

2.5 x 17 cm 2.5 x 22.5 cm

15W | 20W

•51645 •51644 •51648 •51647
•51643 •51646



•1 150 lm
•1 100 lm
•1 050 lm



•1 700 lm
•1 650 lm
•1 600 lm



100-277 V

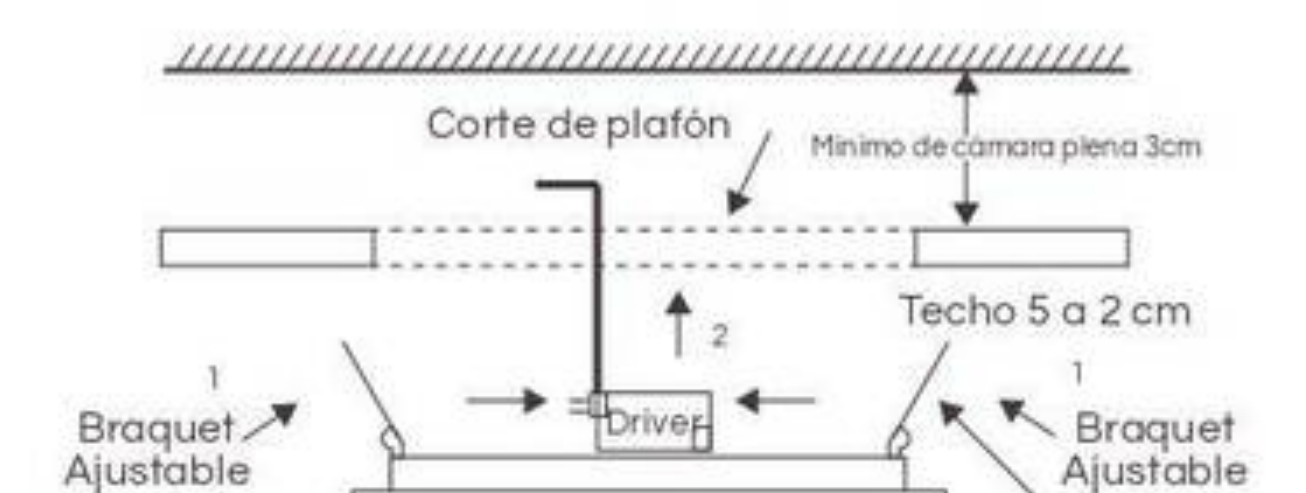

100-240 V



120°



25 000 h



SMD



>80

DOWNLIGHTS PARA SOBREPONER O EMPOTRAR



20W

•57175



17 x 3.2 cm



20W

•57176



17 x 3.2 cm



100-240 V



2 000 lm



180°



25 000 h



SMD

DOWNLIGHTS *LED*



6.5W

•51119 •51128



4.9 x 9.2 cm



•500 lm
•450 lm



25°

6.5W

•51117



7.5 x 9.4 cm



550 lm



38°



Dirigibles

6.5W

•51127



7.5 x 9.4 cm



400 lm



120°



90-260 V



50 000 h



SMD



80

DOWNLIGHTS DIRIGIBLES *LED*

20W

•51585 •51584



3.5 x 23.5 cm



•1 650 lm
•1 620 lm



24°

20W

•51583 •51582



3.5 x 23.5 cm



•1 650 lm
•1 620 lm



120°



100-277 V



30 000 h



SMD



>80



Dirigibles

DOWNLIGHTS DIRIGIBLES LED



6W

•51677



9 x 4 cm



550 lm



6W

•51678



9 x 9 x 4 cm



500 lm



6W

•57137 •57136



9 x 9 x 4 cm



•550 lm
•500 lm



38°



100-240 V



36°



25 000 h



SMD



>80



Dirigibles

PARA MR16



Dirigibles

**LÁMPARA
NO INCLUIDA**

51811
Blanco



51812
Níquel



51813
Cromado



51814
Negro



Fijos

57156
Blanco



57157
Cromado



PANELES LED



35W

Ideal para zonas sísmicas

•51817



60 x 60 cm



3 600 lm



Atenuable
0-10 V



0,95

36W

•51788
•51787
•51786



60 x 60 cm



Con óptica
antideslumbramiento



•3 650 lm
•3 600 lm
•3 550 lm



0,9

45W

•51818

Cambia de Temperatura
← de 2 700 K a 5 700 k →



60 x 60 cm



Compatible con
kit de suspensión

51804

Control remoto(No incluye baterías)



4 500 lm



Atenuable
0-10 V



≥0,95



100-277 V



120°



50 000 h



SMD



>80

PANELES LED



35W

Ideal para zonas sísmicas

51817



60 x 60 cm



3 600 lm



Atenuable
0-10 V



0,95

36W

51788
51787
51786



60 x 60 cm



Con óptica
antideslumbramiento



3 650 lm
3 600 lm
3 550 lm



0,9

45W

51818

Cambia de Temperatura
de 2 700 K a 5 700 k



60 x 60 cm



Compatible con
kit de suspensión

51804

Control remoto(No incluye baterías)



4 500 lm



Atenuable
0-10 V



≥0,95



100-277 V



120°



50 000 h



SMD



>80

PANELES LED

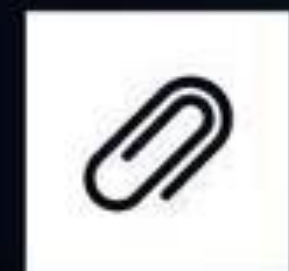

40W

- 51658
- 51657
- 51656



60 x 60 cm



- 3 250 lm
- 3 200 lm
- 3 150 lm

40W

- 51661
- 51660
- 51659



30 x 120 cm



- 3 250 lm
- 3 200 lm
- 3 150 lm

70W

- 51664
- 51663
- 51662



60 x 120 cm



- 5 650 lm
- 5 600 lm
- 5 550 lm



100-240 V



110°



30 000 h

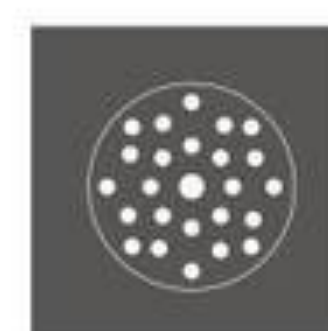

SMD



>80



0,9

Compatibles con kit de suspensión

GABINETES FLUORESCENTES



3x14W

- 51031
- 51180



59.8 x 59.8 cm

2x28W

- 51032



29.8 x 119.8 cm

3x28W

- 51033

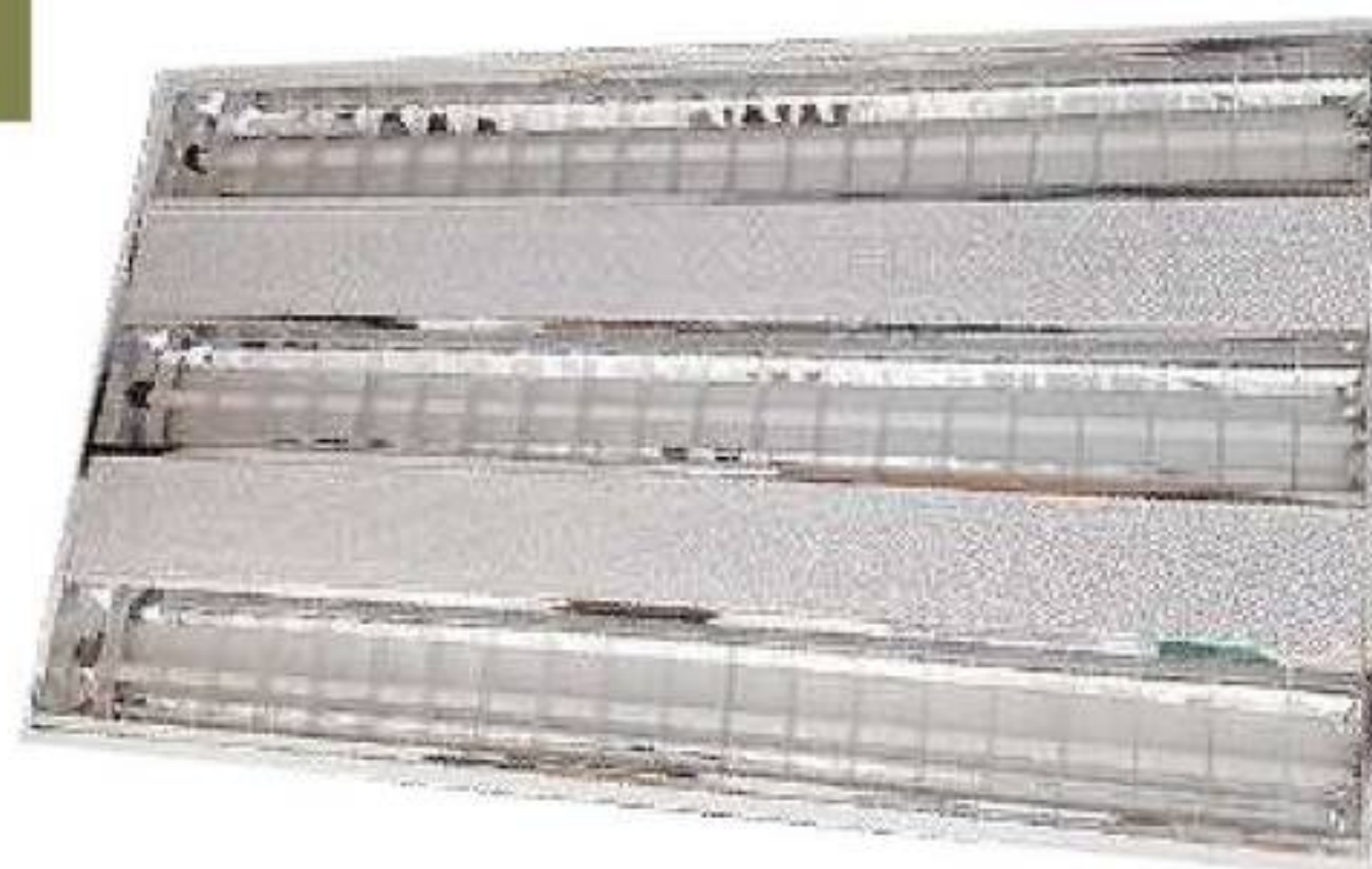

59.8 x 119.8 cm



127 V



G5



>80

INCLUYEN TUBOS FLUORESCENTES T5

INTERCONECTABLES



14W

•51270

Sistema de Inteconexión Lineal



2.5 x 3.5 x 120 cm

Cable 51271



100-240 V



● 1 200 lm
○ 1 150 lm



80

40W

•51518

Incluye kit de suspensión



12 x 120 cm



100-277 V



2 800 lm

40W

•51641



11.3 x 123.6 cm



100-277 V



4 200 lm



35 000 h

14W

•57134

Sistema de Inteconexión Lineal
Óptica transparente



2.2 x 3.3 x 120 cm



100-240 V



1 300 lm



110°



30 000 h

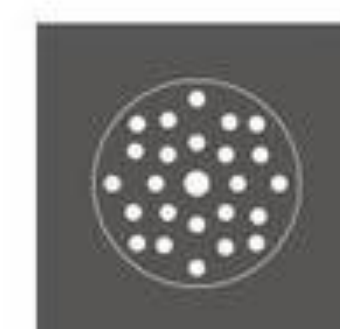

SMD



>80



0,9

DE SUJECIÓN *LED*



20W

•51432



7.5 x 60 cm



1 750 lm



36W

•57117



6 x 120 cm



2 800 lm



85-265 V



140°



30 000 h



SMD



70



0,9

DE SUJECIÓN CON FUENTE DE LUZ INTERCAMBIABLE

 **LÁMPARA
NO INCLUIDA**

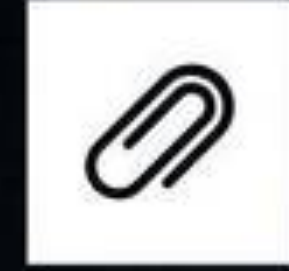

51630



2 x 15 x 120 cm

Para 2 Tubos T8 (Base G13)
Con Acrílico Opalino

51631

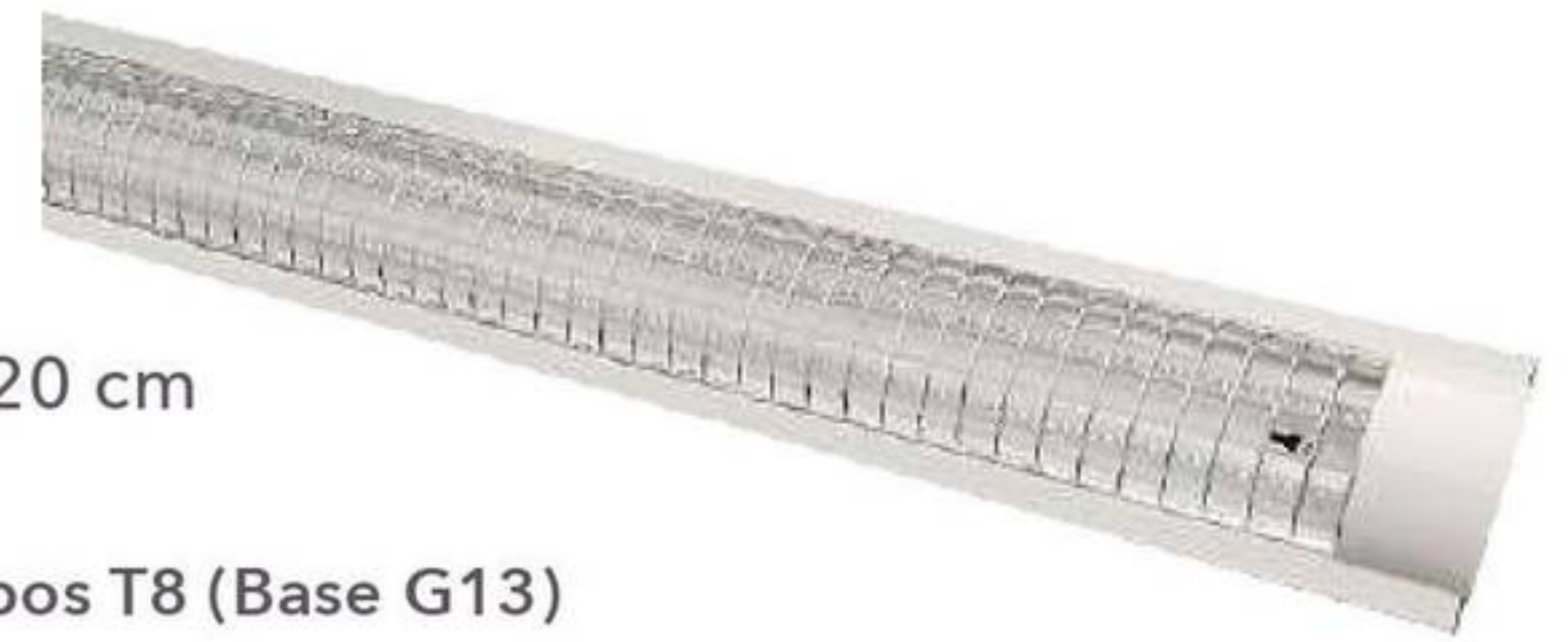

2 x 15 x 120 cm

Para 2 Tubos T8 (Base G13)
Con Rejilla Cromada



G13



Conexión
Ambos lados

57158



17.5 x 120 cm



G13



Conexión
Ambos lados

SALIDA
DE EMERGENCIA





Luminarios de **EMERGENCIA**

Espacios iluminados más seguros
justo cuando lo necesitas.

EMERGENCIA *LED*



1W

•51831



◀ Verde



35.8 x 14.6 x 2.2 cm

2W

•51832



◀ 6 500 K



27 x 25.2 x 6.8 cm

2W

•51833



◀ 6 500 K



31 x 14 x 9 cm



100-240 V



180 minutos
Batería recargable



IP20

6W

•51829



400 lm



◀ 6 500 K



30.5 x 30.5 cm



100-240 V



180 minutos
Batería recargable



IP65

6W

•51268



300 lm



◀ 6 500 K



5.8 x 4.3 x 39.2 cm



110-220 V



Batería 6 h



Batería
recargable

9W

•51450



500 lm



◀ 6 500 K



6 x 4.5 x 58.5 cm



127 V



Batería 8 h



Batería
recargable

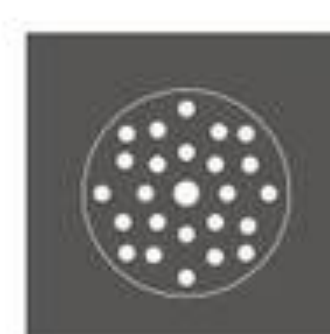

SMD



>80

LUMINARIO RECARGABLE *LED*



10W

•51789

◀ 6 500 K



17 x 12.5 cm



5 V



120°



30 000 h



COB



>80



IP65



IK08



Batería recargable



Puerto de carga

CON SENSOR LED

27W

•51696

◀ 6 500 K



11.9 x 16.3 x 37.5 cm



100-240 V



1 200 lm



110°



25 000 h

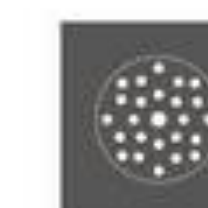

SMD



>80



IP44





Luminarios de **MESA**

Mejor productividad con espacios de estudio mejor iluminados.

Infantiles Infantiles

De Escritorio de LED

Suspendidos

Lámpara de noche

Bocina Bluetooth

Luminarios de Escritorio

INFANTILES DE ESCRITORIO *LED*



1W

•50966



13.4 x 14.7 x 21.2 cm

1W

•51028



13.5 x 11.6 x 19.2 cm



Atenuable

1W

•51464



10 x 18.2 cm

1W

•50967



12 x 10 x 22 cm

1W

•51029



12 x 10 x 22 cm

1W

•51465



10 x 18.2 cm



100-277 V

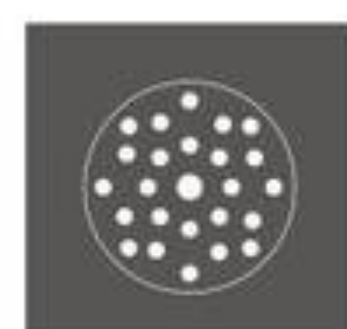

SMD



Batería 8h baja intensidad
Batería 4h alta intensidad

INFANTILES DE ESCRITORIO *LED*



🔌 Incluye Cable USB
Encendido al tacto

1W

•51467



RGB

12.2 x 15.3 cm

1W

•51468



RGB

12.2 x 15.3 cm

1W

•51469



RGB

12.2 x 15.3 cm



Batería Recargable
Luz Blanca: 15 hrs
Luz de Color: 12 hrs

5 V c.d.

SMD

LUMINARIOS INFANTILES CON FUENTE DE LUZ INTERCAMBIABLE



LÁMPARA
NO INCLUIDA



E12



51712

23 x 17.6 x 26.2 cm



51713

20 x 17.5 x 24.8 cm



51714

22 x 19.5 x 25 cm

INFANTILES SUSPENDIDOS



LÁMPARA
NO INCLUIDA



51715



2 Bases E12



1 Base GU10



51717



1 Base E12



51719



1 Base E12



51716



2 Bases E26

LUZ DE NOCHE



CON SENSOR LUZ INTEGRADA

1W

•51702



3 000 K



3.5 x 8.4 x 12.9 cm



127 V



Con 4
tomacorriente



Con 2
puertos USB

1W

•51703



3 000 K



9.6 x 5.9 cm



100-240 V



Con 2
puertos USB

1W

•51357



8 000 K



4.5 x 8.3 cm



127 V



20 000 h



SMD

RELOJ DESPERTADOR *LED*

10W

•51711
Radio FM

RGB



5.2 x 15.5 x 20.6 cm



5 V c.d.



Con altavoz



SMD

BOCINA BLUETOOTH LED



3W

•51466

RGB



📶 10 m Alcance de Bluetooth

📞 Recepción de llamadas

➔ Incluye Cable USB

Entrada AX y
Micro SD

11 x 13 cm



5 V c.d.



Batería
Recargable



SMD

ARO DE LUZ PARA SMARTPHONE

24W

■57177

Atenuable
Cambia de Temperatura
3 000 K / 4 100 K / 5 500 K



Incluye control Remoto

25.5 x 2.7 cm



5 V



180°



25 000 h



SMD

DE ESCRITORIO *LED*

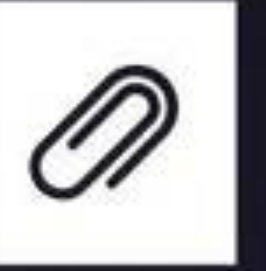

4.5W

•51243



17 x 38.5 cm



4.5W

•51244



17 x 38.5 cm



TECNOLOGÍA
LED



480 lm



30 000 h



Atenuable
al tacto



Puertos de
carga USB

7W

•51408

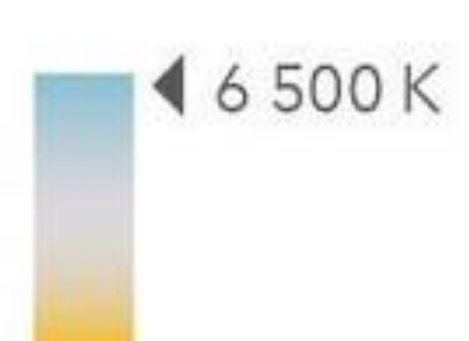

18 x 40 cm



7W

•51410



33.5 x 43.5 cm

Incluye Lupa



TECNOLOGÍA
LED



100-240 V



360 lm



25 000 h



SMD

IRC

>80

DE MESA



51750

28 x 42 cm



51749

24 x 41 cm



E26





Placas y

MECANISMOS

Amplia gama de colores para cualquier aplicación.

PLACAS Y MECANISMOS



PLACAS BLANCAS ARMADAS



51015



51017



51018

8 x 12 cm

PLACAS DE COLORES



51020
Blanche



51021
Champagne Claro



51022
Aluminio



51023
Champagne Oscuro



51024
Grafito



51025
Roble

8 x 12 cm

PLACAS Y MECANISMOS



APAGADORES



51004
Interruptor Sencillo Estándar
10A 130/250 V 50/60 Hz

51005
Interruptor Escalera Estándar
10A 130/250 V 50/60 Hz

51006
Botón de Timbre Estándar
10A 130/250 V 50/60 Hz



51001
Botón de Timbre 4 vías
Múltiples Escaleras
130 V 16A 130/250 V 50/60 Hz

51002
Interruptor Escalera con Piloto Premium
130 V 16A 130/250 V 50/60 Hz

51003
Botón de Timbre con Piloto Premium
130 V 16A 130/250 V 50/60 Hz

MECANISMOS



51007
Conector 2 polos y tierra
15A 130/250 V
50/60 Hz

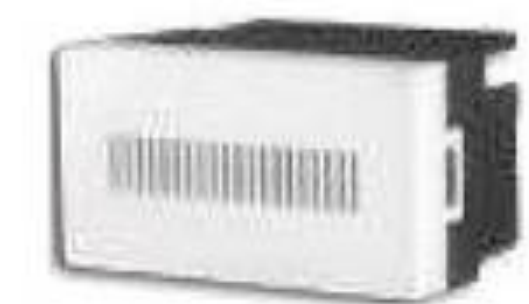

51009
Zumbador Luminoso
16A 120 V 50/60 Hz

PLACAS Y MECANISMOS SICA



556831



350503



351503
Escalera

352503
Timbre

VENTILADORES Y EXTRACTORES

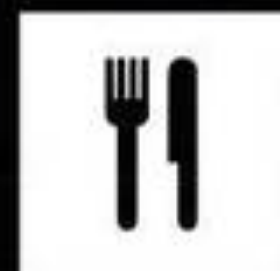

LÁMPARA
NO INCLUIDA



57060
Acabado negro



57059
Acabado blanco

ON
OFF Control por cadena de tracción



127 V



3 niveles
de velocidad



Función
inversa



Usa 1 lámpara
base E26

12W

51617
4" 90m³/h

17W

51618
6" 120m³/h



127 V





Luminarios de **EXTERIOR**

Protección para cualquier ambiente.

Reflectores

RGB

Alta Potencia

Industriales

Arbotantes

Suburbano

Street Lighting

Solares

Luminarios Outdoor

De empotrar

Con Estaca

Postes para exterior

Wall Washers

A prueba de polvo y agua

REFLECTORES *LED*



20W

• 51188



17.9 x 13 cm



100-240 V



1 300 lm



110°



40 000 h



SMD



>70



IP65

135W

• 57113



32.5 x 4.5 x 23.5 cm



12 000 lm

180W

• 57114



32.5 x 4.5 x 23.5 cm



16 000 lm



100-240 V



120°



30 000 h

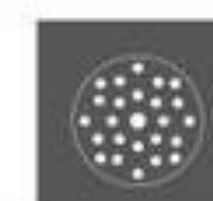

SMD



>0,9



IP65

REFLECTORES *LED*



30W

• 51896



17 x 16 x 4 cm



2 700 lm

50W

• 51879



20 x 19 x 5 cm



4 500 lm

70W

• 51637



27.7 x 32.1 cm



5 600 lm

100W

• 57012



36 x 28.5 cm



8 000 lm

200W

• 57013



44 x 32.5 cm



16 000 lm



100-240 V



120°



35 000 h

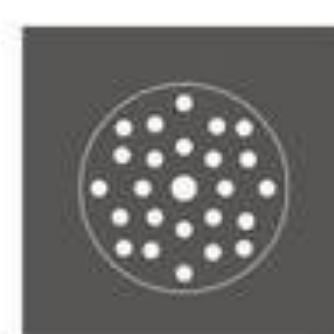

SMD



>80



IP65

REFLECTORES RGB

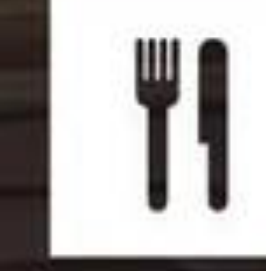

30W

•57016

RGB



22.5 x 18.5 x 14 cm

50W

•57017

RGB



28 x 23.5 x 15.8 cm

100W

•57018

RGB



36 x 28.7 x 10 cm



100-240 V



120°



30 000 h



COB



>0,9



IP65

REFLECTORES ALTAS POTENCIAS



240W

• 51483



43.5 x 34.1 x 19 cm



31 200 lm

360W

• 51484



61.8 x 34.1 x 20 cm



46 800 lm

480W

• 51485



57.9 x 44.2 x 20.1 cm



62 400 lm



100-277 V



120°



50 000 h

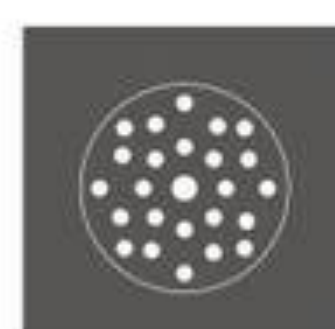

SMD



>80



0,95



IP65

INDUSTRIALES



120W

Acabado Transparente
Incluye Kit de suspensión

51494



91.2 x 10.4 cm



15 000 lm



50 000 h



IP65



90°

120W

50955



120 x 10.2 x 6 cm



9 800 lm



25 000 h



IP53



51873
Kit de suspensión

160W

51872 122 x 24 x 4.5 cm



19 200 lm

90W

51633

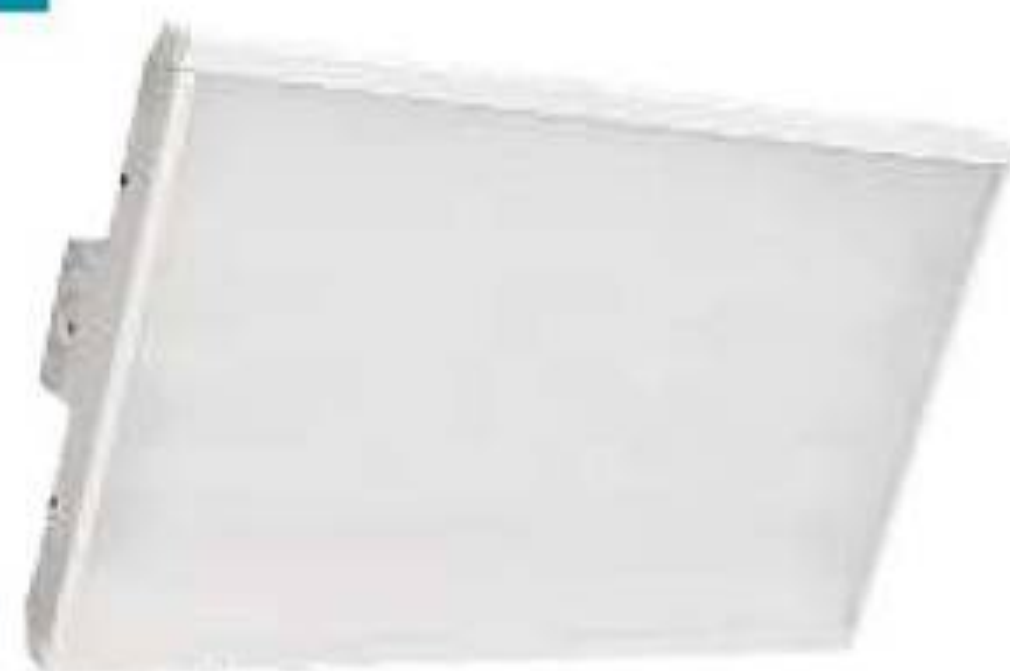

35.4 x 56.3 cm



10 000 lm



110°



30 000 h

180W

51634



116.3 x 35.4 cm



20 000 lm

220W

51871



26 400 lm

TECNOLOGIA
LED



100-277 V



120°



35 000 h

TECNOLOGIA
LED



100-277 V



SMD

IRC

>80

HPF

0,95



SMD

IRC

>80

HPF

0,9

INDUSTRIALES



ALTA EFICIENCIA *LED*

190
lm/W

70W

• 57019



30 x 16.8 cm



13 300 lm



110W

• 57020



34 x 16.9 cm



20 900 lm



90-305 V



120°



50 000 h



SMD



>80



0,95



IP65

CAMPANA DE ALTURA AJUSTABLE

50W

• 51729



30 x 23.5 cm



4 500 lm



Uso interior



100-240 V



120°



50 000 h



SMD



80



IP20

INDUSTRIALES



40W

• 57084



23 x 23 cm



4 800 lm



Atenuable

80W

• 57085

32.5 x 32.5 cm



9 500 lm

26W

• 51790



23.4 x 15.3 x 9.2 cm



Con Fococelda



2 860 lm

50W

• 51284



36 x 23 x 18.5 cm



4 800 lm



35 000 h



100-277 V



120°



50 000 h

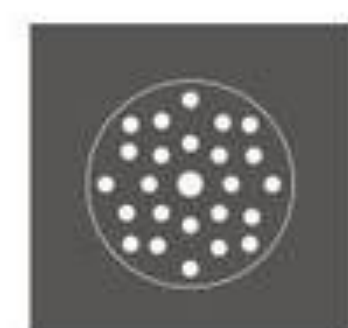

SMD



80



0,9



IP65

INDUSTRIALES



100W **140**
lm/W

• 57173



28 x 16.5 cm



14 000 lm



120°

120W **134**
lm/W

• 57140



33 x 15.5 cm



16 100 lm

150W **127**
lm/W

• 57184



28 x 16.5 cm



19 000 lm



120°

200W **135**
lm/W

• 57174



39 x 17.8



27 000 lm

240W **133**
lm/W

• 57141



39 x 15.5 cm



32 000 lm



100-277 V



90°



50 000 h

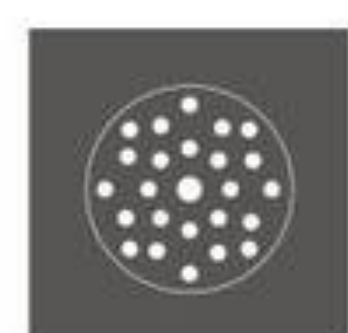

SMD



>80



0,95



IP65

ARBOTANTES



3W

• 51917



8 x 6.5 x 7.5 cm



170 lm



Luz Directa

6W

• 51918



8 x 6.5 x 14 cm



280 lm



Luz Directa e Indirecta

12W

• 51919



6.5 x 8 x 15 cm



720 lm



Luz Directa e Indirecta

12W

• 51920



6.8 x 8 x 15 cm



760 lm



Luz Directa e Indirecta

6W

• 51921



12 x 12.5 x 6.7 cm



380 lm



Luz Directa



45°



90-265 V



90°



25 000 h



COB



IP54

ARBOTANTES



6W

• 51922



◀ 3 000 K



11 x 10.8 x 7 cm



220 lm



Luz Directa e Indirecta



160°

6W

• 51924



◀ 3 000 K



10.2 x 10.2 cm



290 lm



Luz Directa e Indirecta



Ángulo de apertura ajustable

12W

• 51923



◀ 3 000 K



21 x 7 x 7 cm



320 lm



Luz Directa e Indirecta



90°

6W

• 51925



◀ 3 000 K



18 x 12 x 7.5 cm



200 lm



Luz Indirecta



160°

6W

• 51926



◀ 3 000 K



17 x 9 x 7 cm



200 lm



Luz Directa e Indirecta



60°

6W

• 51927



◀ 3 000 K



17 x 8 x 4 cm



350 lm



Luz Directa e Indirecta



160°



TECNOLOGÍA
LED



90-265 V



25 000 h



COB



IP54

ARBOTANTES



3W
• 51302

3 000 K

16.4 x 8.2 x 5.45 cm



58 lm Luz Directa

3W
• 51303

3 000 K

16.4 x 8.2 x 5.45 cm



80 lm Luz Directa e Indirecta

100-240 V 25 000 h

6W
• 51739

3 000 K

16 x 10 x 6.5 cm



300 lm Luz Directa e Indirecta 90-265 V 35 000 h



COB

IP54

ARBOTANTES



12W

• 51801



15 x 12 x 10.3 cm



490 lm

12W

• 51802



21.5 x 10 x 7.5 cm



820 lm

12W

• 51803



21.5 x 10 x 7.5 cm



860 lm



100-240 V



25 000 h



SMD



>80



IP65



Luz Indirecta

ARBOTANTES



4W

• 51304



3 000 K



16 x 16 x 6.35 cm



137 lm



Luz Directa

7W

• 51305



3 000 K



16 x 16 x 6.35 cm



260 lm



Luz Directa e Indirecta

4W

• 51306



3 000 K



9 x 9.5 x 6.5 cm



50 lm



Luz Directa

7W

• 51307



3 000 K



16 x 9.5 x 6.5 cm



230 lm



Luz Directa e Indirecta

8W

• 51301



3 000 K



17 x 11.5 x 7 cm



50 lm



Luz Directa



100-240 V



25 000 h



COB



80



IP54

ARBOTANTES



3W

• 51453 • 51452

◀ 6 500 K
◀ 3 000 K



10 x 10 cm

140 lm

IND
DIR

Luz Directa e Indirecta

6W

• 51455 • 51454

◀ 6 500 K
◀ 3 000 K



20 x 8 cm

300 lm

IND
DIR

Luz Directa e Indirecta

6W

• 51457 • 51456

◀ 6 500 K
◀ 3 000 K



20 x 12 cm

500 lm

IND

Luz Indirecta

4.5W

• 51740

◀ 6 500 K
◀ 3 000 K



18.5 x 13.8 cm

150 lm

DIR

Luz Directa

TECNOLOGIA LED

85-265 V

25 000 h

SMD

>80

IP44

TECNOLOGIA LED

100-240 V

100°

35 000 h

SMD

IRC >80

CON FUENTE DE LUZ INTERCAMBIABLE



51294

2 bases GU10

IND
DIR

Luz Directa e Indirecta



51293

1 base GU10

DIR

Luz Directa



IP54



ARBOTANTES



7W
• 51238
◀ 6 500 K

21.2 x 11.8 x 8.5 cm



7W
• 51239
◀ 6 500 K

21.2 x 11.8 x 8.5 cm



18W
• 51329 • 51328
◀ 6 500 K
◀ 3 000 K

19.5 x 19 cm



18W
• 51313
◀ 6 500 K

19.5 x 19 cm



10W
• 51471
◀ 6 500 K

24 x 12 cm



13W
• 51472
◀ 6 500 K

21 x 17 cm

Contiene Estaca y Bracket



LUMINARIO TIPO FARO

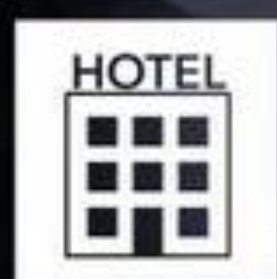

35W

• 57058



◀ 3 000 K



15 x 25 x 23 cm



110-260 V



2 400 lm



120°



25 000 h



IP54

PUNTA DE POSTE COLONIAL

60W

• 57190



◀ 6 500 K



100-305 V



6 500 lm



154°



30 000 h



IP65



IK08



SMD



>80

SUBURBANOS LED



CON FUENTE DE LUZ INTERCAMBIABLE

60W

• 57193



50W

• 51613



37.2 x 25 cm

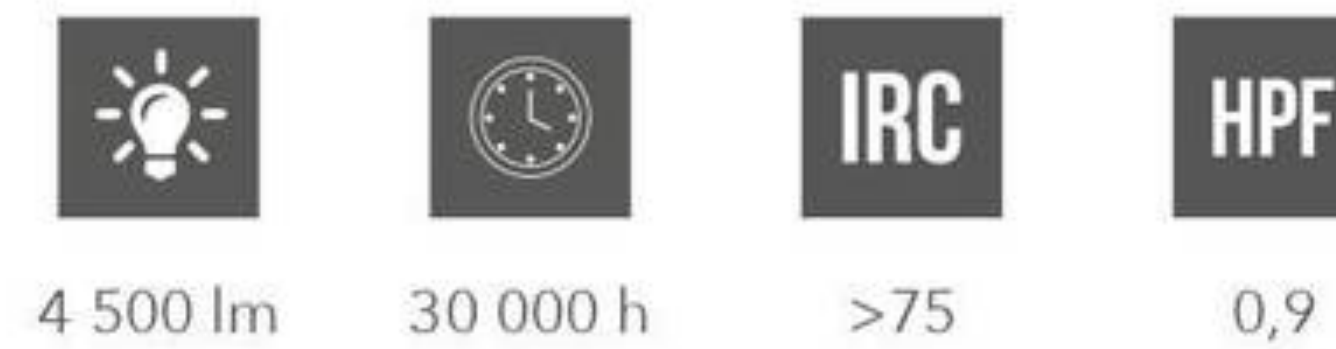

50W

• 57083



Incluye brazo de sujeción



37.2 x 25 cm



35W

• 51791



Incluye brazo de sujeción



26.2 x 16.6 cm



51940
Base E26

51941
Base E39



37.2 x 25 cm

Con Fococelda

Con Fococelda



100-240 V



120°

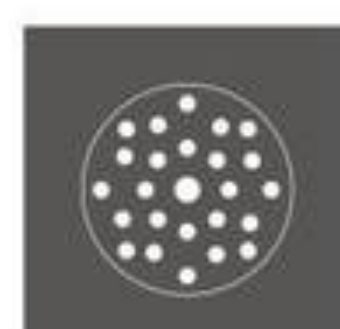

SMD



IP65



IP65

STREET LIGHTING *LED*



60W

◉ 57054



7.8 x 49 cm



7 200 lm



80W

◉ 57055



19 x 40 cm



9 600 lm



100W

◉ 57056



27 x 71.5 cm



12 000 lm



120W

◉ 57057



19 x 40 cm



14 400 lm

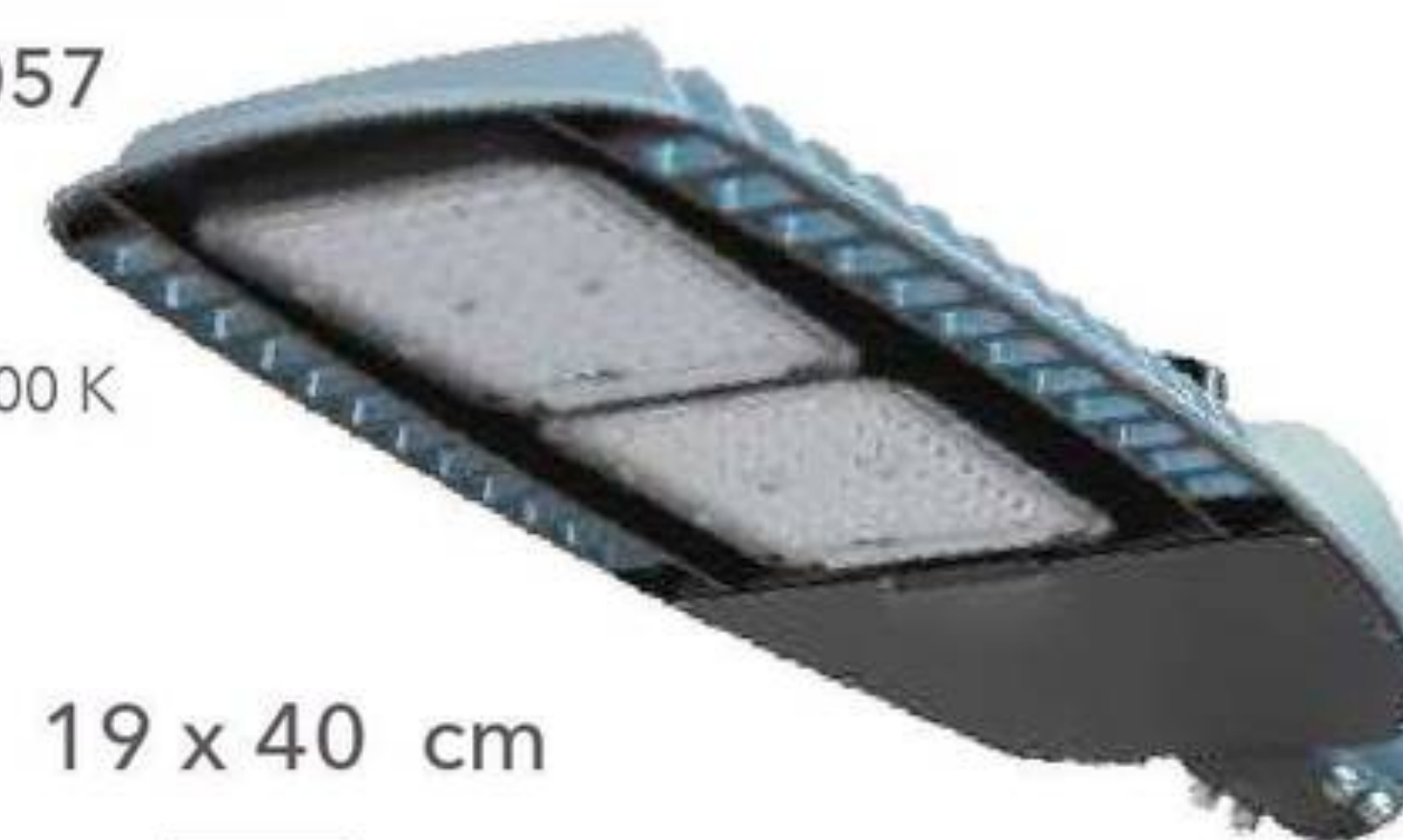

Curva II Media | Supresor de picos 10 kV

Con receptáculo | Sin fotocelda



100-277 V



50 000 h



SMD



0,9



IP66

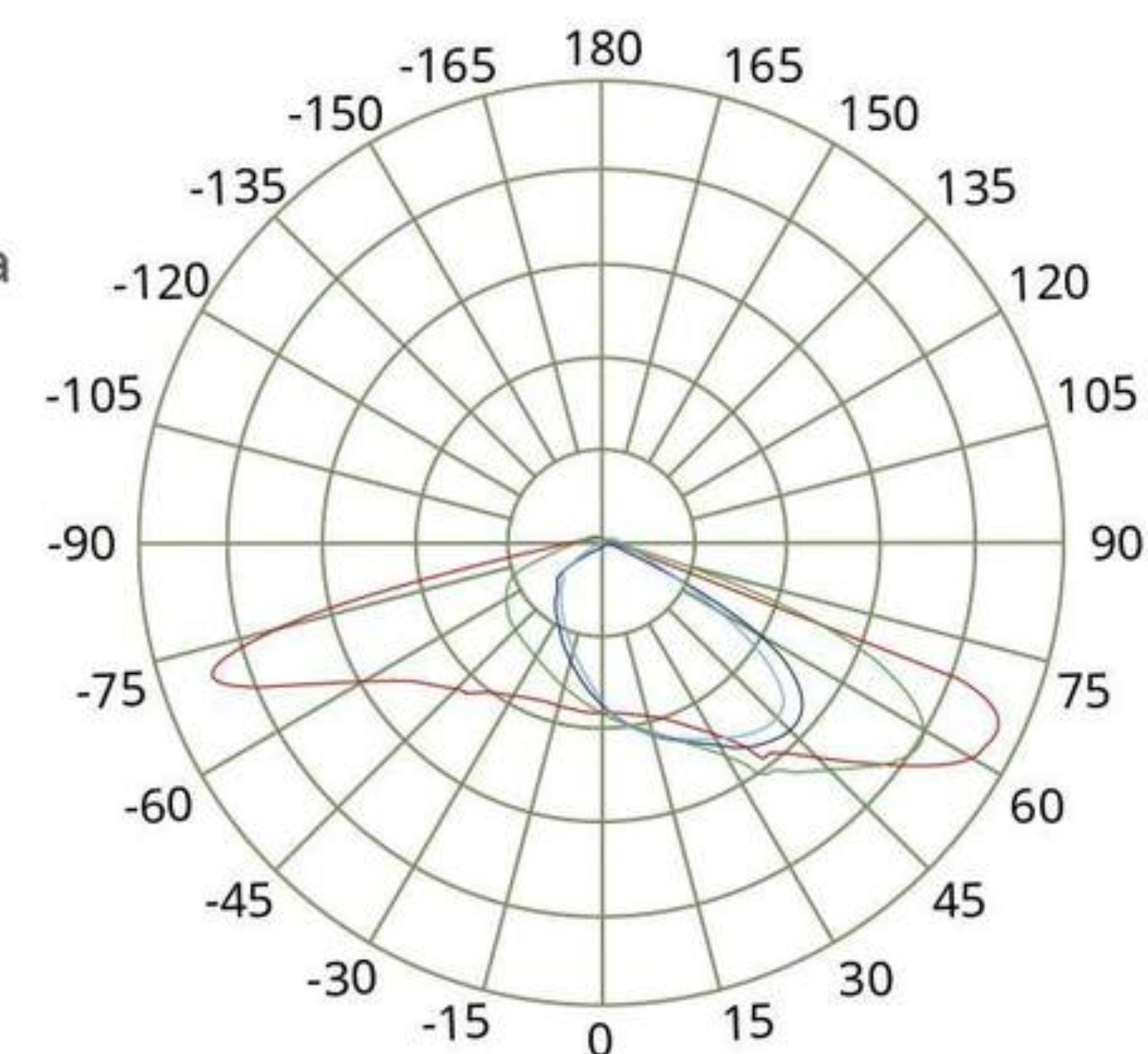

STREET LIGHTING LED



60W

● 57000



19 x 40 cm



7 000 lm



Supresor de picos 20 kV
Con opción a fotocelda
Curva II Media

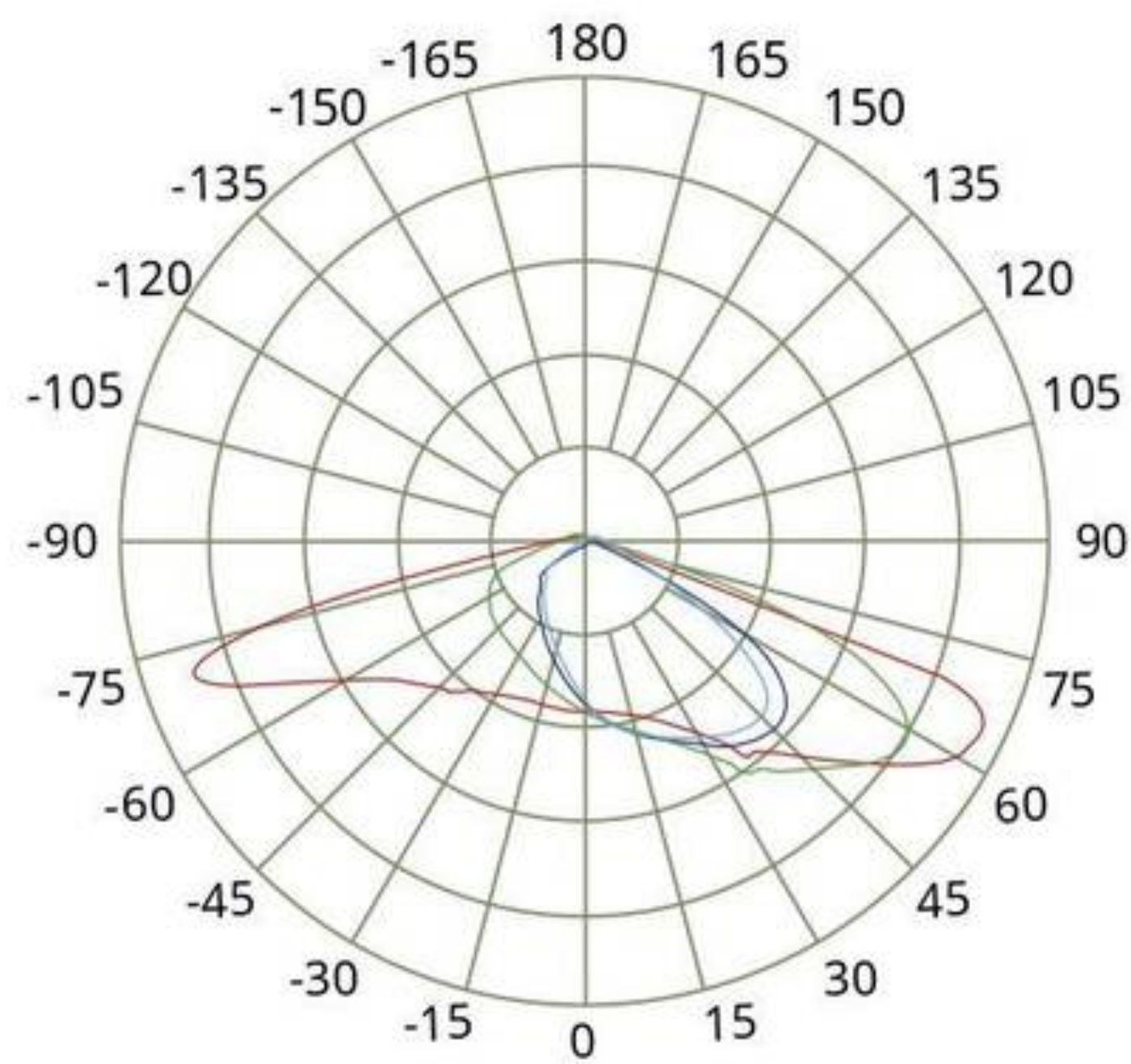

100-277 V



50 000 h

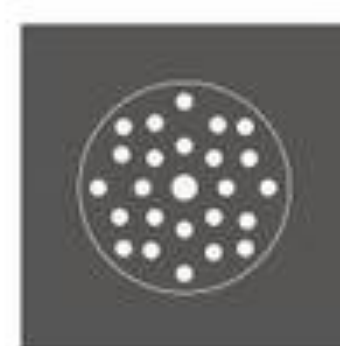

SMD



>80



0,9



IP65



IK08

30W

● 57130



3 600 lm

50W

● 57131



6 000 lm

100W

● 57132



12 000 lm

150W

● 57133



18 000 lm



Supresor de picos 4 kV
Curva III



30W: 14 x 37 cm
50W: 17.5 x 43 cm
100W: 25.5 x 53 cm
150W: 25.5 x 55 cm

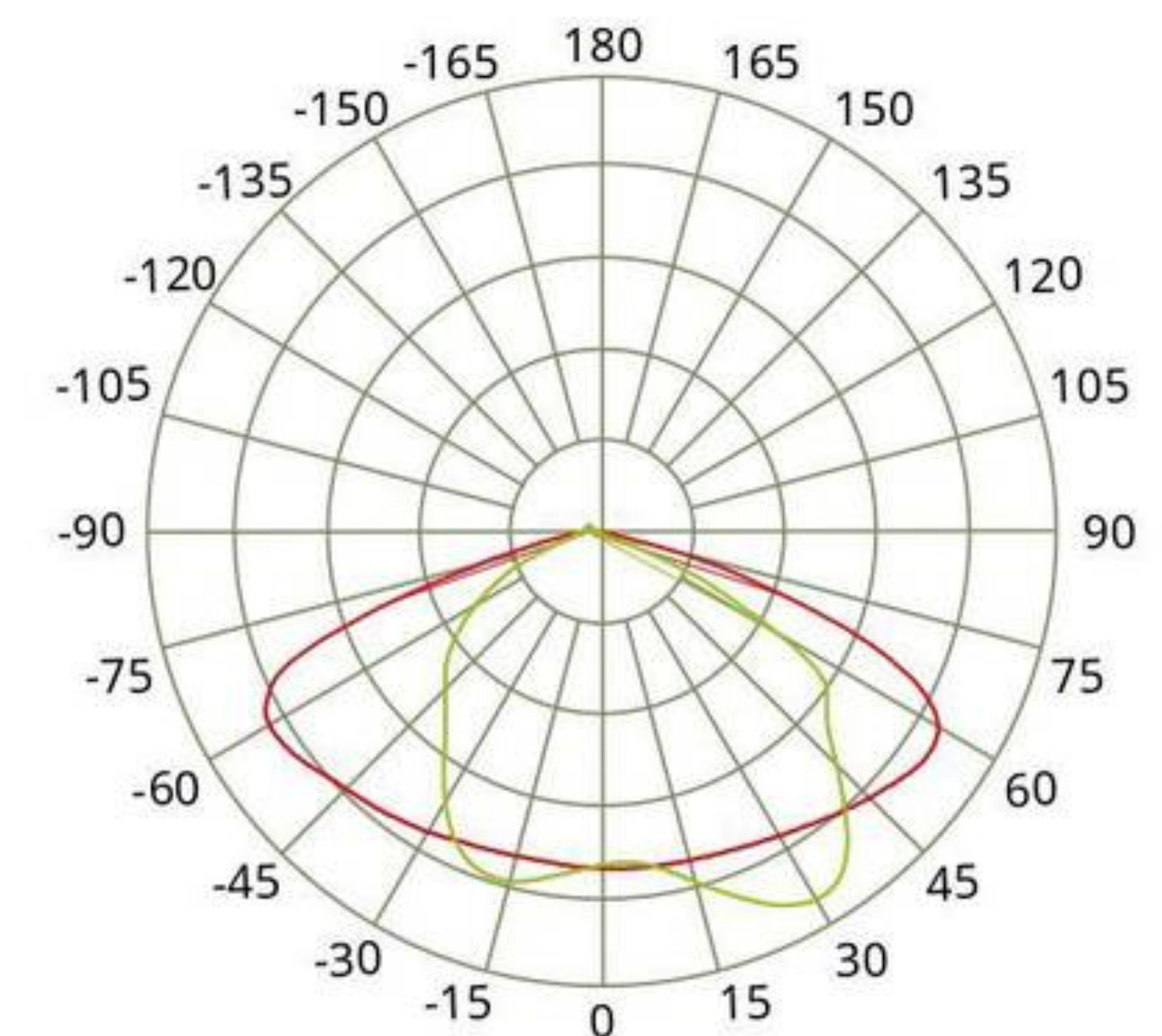

100-265 V



30 000 h



SMD



>0,9



IP65



IK08

SOLAR LED



Con sensor PIR
Operación al 20% en reposo

50W

57067



Panel: 87 x 2.5 x 67 cm
Luminario: 88 x 33 x 9.5 cm



6 000 lm

60W

51898



Panel: 87 x 2.5 x 67 cm
Luminario: 88 x 33 x 9.5 cm



7 800 lm

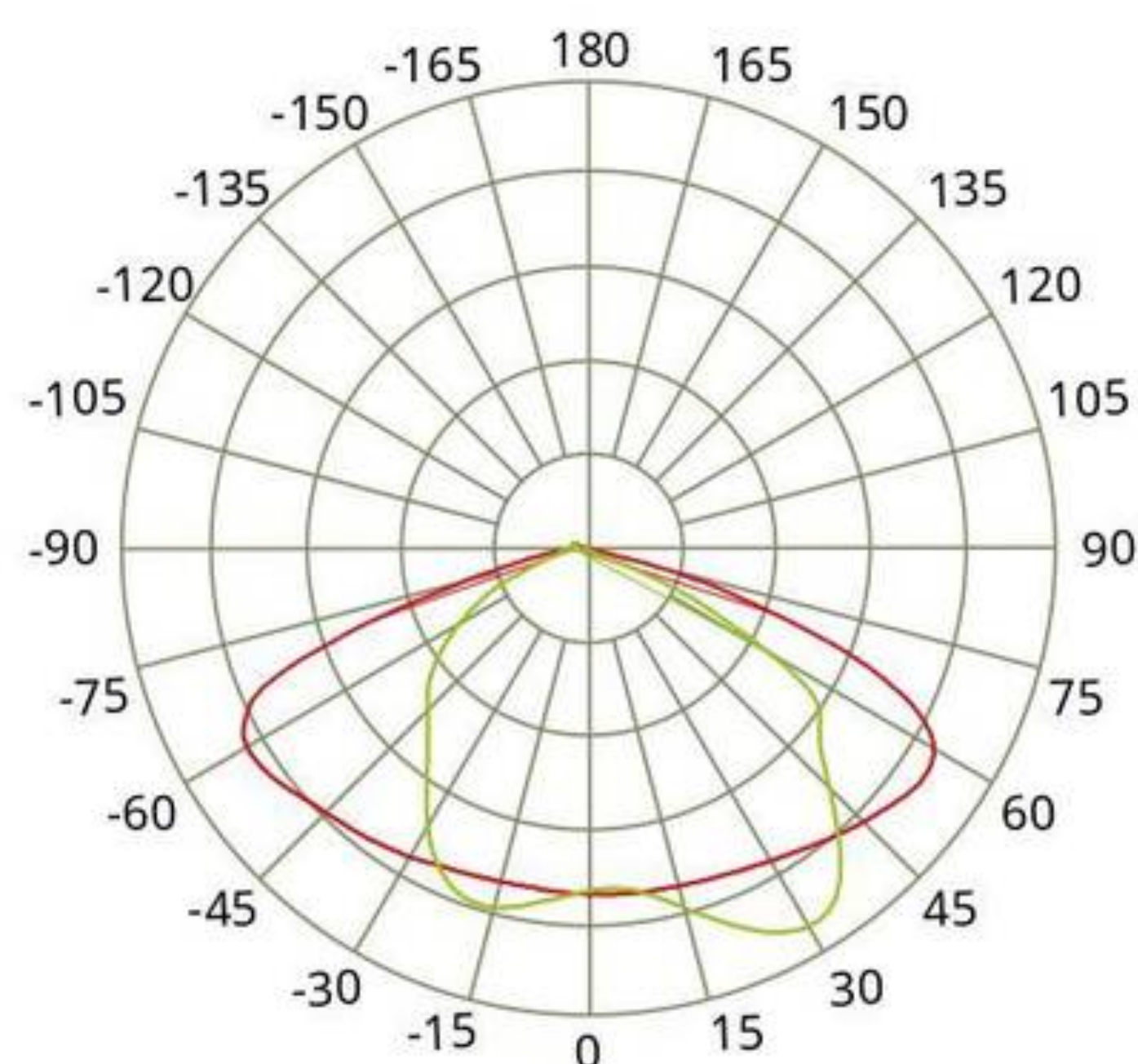

Curva III



18 V



50 000 h



SMD



>75



IP65

LUMINARIOS SOLARES



10W

• 51438

◀ 6 500 K



13.5 x 11.5 x 4.2 cm
Panel Solar: 20.4 x 16.3 x 1.9 cm



700 lm

Incluye panel solar
Incluye sensor de movimiento

20W

• 51439

◀ 6 500 K



18.5 x 15.5 x 5 cm
Panel Solar: 27.2 x 20.3 x 2.3 cm



1 200 lm



25 000 h



IP65

8W

• 51695-1

◀ 6 500 K



25 x 23 x 13.6 cm

Incluye panel solar
Incluye sensor de movimiento



600 lm



25 000 h



IP44

Incluyen panel solar

3W

• 57053

◀ 3 500 K



41 x 17.5 cm



120 lm



120°



IP54

2W

• 51928

◀ 3 500 K



24.5 x 24.5 cm



300 lm



60°



COB



IP65



8h de autonomía
Batería recargable

1W

• 51930

◀ 3 500 K



12 x 12.7 cm



100 lm



120°



>80



IP65



8h de autonomía
Batería recargable

LUMINARIOS SOLARES



Incluyen panel solar

2W

• 51441



22 x 3 cm



160 lm



IP54



8h de autonomía
Batería recargable



25 000 h

2W

• 51929



24 x 37 cm



300 lm



60°



8h de autonomía
Batería recargable

2W

• 51977

LED



◀ FLAMA



**EFEECTO
FLAMA**

11 x 78 cm

TECNOLOGÍA
LED



360°



8h de autonomía
Batería recargable

Incluye panel solar
Incluye sensor de movimiento

SERIE DE JARDÍN

Incluye panel solar

1W

• 51933



28 x 11.5 cm



6h de autonomía
Batería recargable

Serie de 20 metros



IP65

OUTDOOR PARA EMPOTRAR

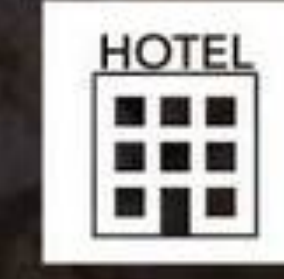



2W
• 51741
◀ 3 000 K
5 x 9 cm



 25 lm
 320°
 IP67



3W
• 51736
◀ 3 000 K
5.2 x 8.25 cm



 150 lm
 30°



9W
• 51737
◀ 3 000 K
10 x 9 cm



 450 lm
 30°

15W
• 51738
◀ 3 000 K
15 x 11 cm



 900 lm
 38°

51742



9.5 x 9.5 cm

 GU10



100-240 V

35 000 h

COB

>70

IP65

OUTDOOR PARA EMPOTRAR



51361



GU10



Diámetro: 9.7 cm

51362



GU5.3

51363



GU5.3



Diámetro: 9.7 cm

ACCESORIOS PARA LUMINARIOS DE PISO



51378

1.5W

• 51358



SLIM

Diámetro: 9.7 cm



82 lm

4W

• 51360 • 51359



Diámetro: 9.7 cm



• 318 lm
• 245 lm

* Compatibles con el accesorio 51379

** Compatible con el accesorio 51378



100-220 V



50 000 h



SMD



>80



IP67



51379

OUTDOOR CON ESTACA



3W

• 51732



5 x 27 cm



150 lm



30°



7W

• 51733



6.5 x 28 cm



350 lm



9W

• 51734



6.5 x 28 cm



450 lm



15W

• 51735



7.5 x 28 cm



900 lm



10W

• 51916



8 x 7 x 32.5 cm



470 lm



90-265 V



38°



IP54



TECNOLOGÍA
LED



100-220 V



35°



35 000 h



COB

IRC

>70



IP65

Incluye Estaca y Bracket

MINI POSTES

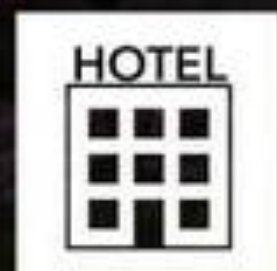
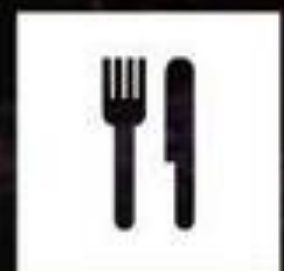

5W

● 51299



8.6 x 65 cm



250 lm



7W

● 57038 ● 57037



10.4 x 30 cm



450 lm



350°



11W

● 57034 ● 57033



9 x 50 cm



810 lm



160°



11W

● 57036 ● 57035



16 x 80 cm



733 lm



85°



100-240 V



35 000 h



SMD



>80



>0,9



IP54

WALL WASHERS *LED*



9W

• 51884



8.5 x 13.8 cm



650 lm



15°

36W

• 51885



18 x 14 cm



2 100 lm



30°

48W

• 51886



28 x 20.7 x 16.3 cm



3 000 lm



30°

24W

• 51887



100 x 3.3 x 2.5 cm



2 000 lm



45°

36W

• 51888



100 x 6.5 x 4.5 cm



2 400 lm



60°



100-277 V



50 000 h



80



0,9



IP67

WALL WASHERS RGB LED



36W

• 51890

RGB



30°

18 x 14 cm



24W

• 51892

RGB



45°

100 x 3.3 x 2.5 cm



48W

• 51893

RGB



65°

100 x 9.8 x 3 cm



DRIVER

360W

51894



24 V



50 000 h



0,9



IP65

A PRUEBA DE POLVO Y AGUA



22W

• 57003



120 cm



LED



2 800 lm



110-277V

2x18W

• 51999



117 cm



Incluye 2 Tubos Opalinos de LED

Sin platina

Con Clips de PC



3 400 lm



110-240V



Conexión
1 lado



120°



30 000 h



SMD



>80



0,95



IP65

2x22W

51836

* Compatible con sensor 57004



LÁMPARA
NO INCLUIDA



126 cm



51835

Accesorio Clip Metálico
(Se vende por separado)



G13



Conexión
Ambos lados

Montaje de sobreponer fabricado en PC con clips de PC y difusor de policarbonato para lámparas T5 ó T8.

1x9W

51289

Para Tubos T5 y T8



LÁMPARA
NO INCLUIDA



7.5 x 66 cm



G13



Conexión
Ambos lados



IP65

A PRUEBA DE POLVO Y AGUA



2x9W

* Compatible con sensor 57004

51139



LÁMPARA
NO INCLUIDA



11.5 x 66 cm

1x22W

51138



LÁMPARA
NO INCLUIDA



11.5 x 66 cm

Montaje de sobreponer fabricado en PC con clips de acero inoxidable y difusor de policarbonato para lámparas T5 ó T8.



G13



Conexión
Ambos lados



IP65

1W

57004

Sensor de movimiento PIR



8.5 x 4 x 3.8 cm



110-277V



IP20





Tiras de **LED**

Perfectas para crear
ambientes vanguardistas.

Carrete 50 metros
Neón
De color
IP20 120 LEDs / metro
IP20 60 LEDs / metro

TIRAS LED



14W/m

50923

6 500 K



1.5 x 0.7 cm



Atenuable



14W/m

51824

4 100 K



1.5 x 0.7 cm



Atenuable



14W/m

51030

3 000 K

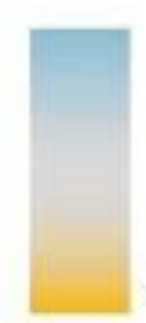

1.5 x 0.7 cm



Atenuable



14W/m

50924

RGB

1.5 x 0.7 cm



Carrete de 50 metros
60 LEDs por metro



120 V



25 000 h

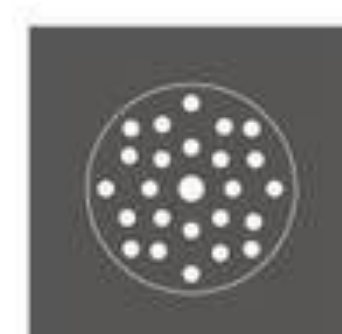

SMD



>70



IP65



Corte cada
50 cm

ACCESORIOS

MONOCROMÁTICAS



50925
Pines



50927
Tapas



50932
Rectificador
1 color



50929
Conector



51070
Clips

RGB



50926
Pines



50928
Tapas



50933
Rectificador
RGB



50930
Conector



51071
Clips

TIRAS LED



6,5W/m

• 57142



1.5 x 0.7 cm



Atenuable



14W/m

• 57143



1.5 x 0.7 cm



Atenuable



Carrete de 50 metros
60 LEDs por metro

ACCESORIOS

MONOCROMÁTICAS



57144
Pines



57172
Rectificador
1 color



57171
Tapas



57178
Clips



TECNOLOGÍA
LED



120 V



25 000 h

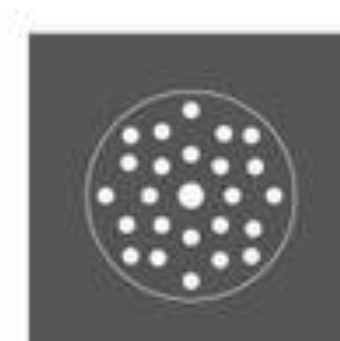

SMD



>70



IP65



Corte cada
50 cm

TIRAS NEÓN

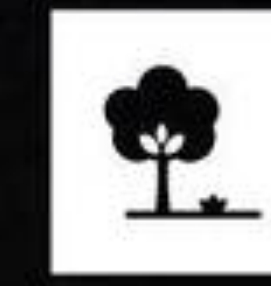

10W/m

• 57097



◀ Azul

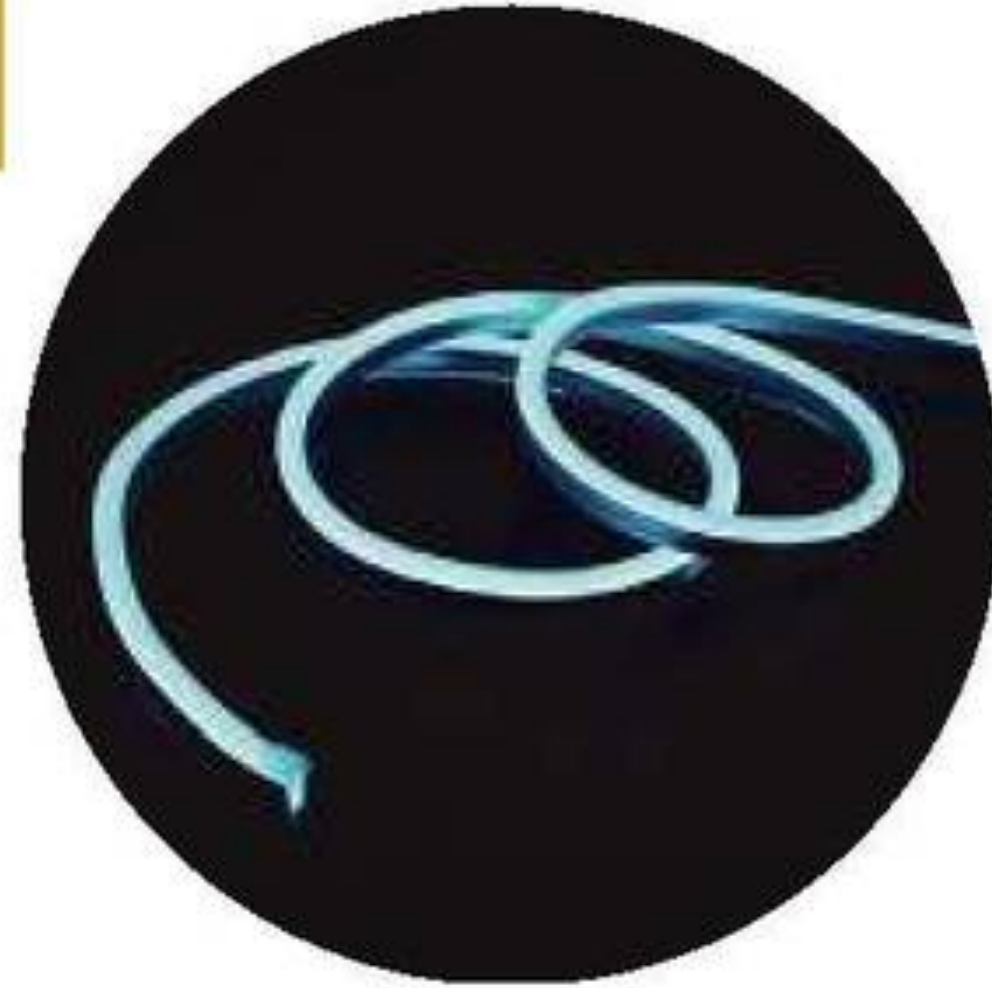

1 x 1.8 cm

10W/m

• 57097



◀ Verde

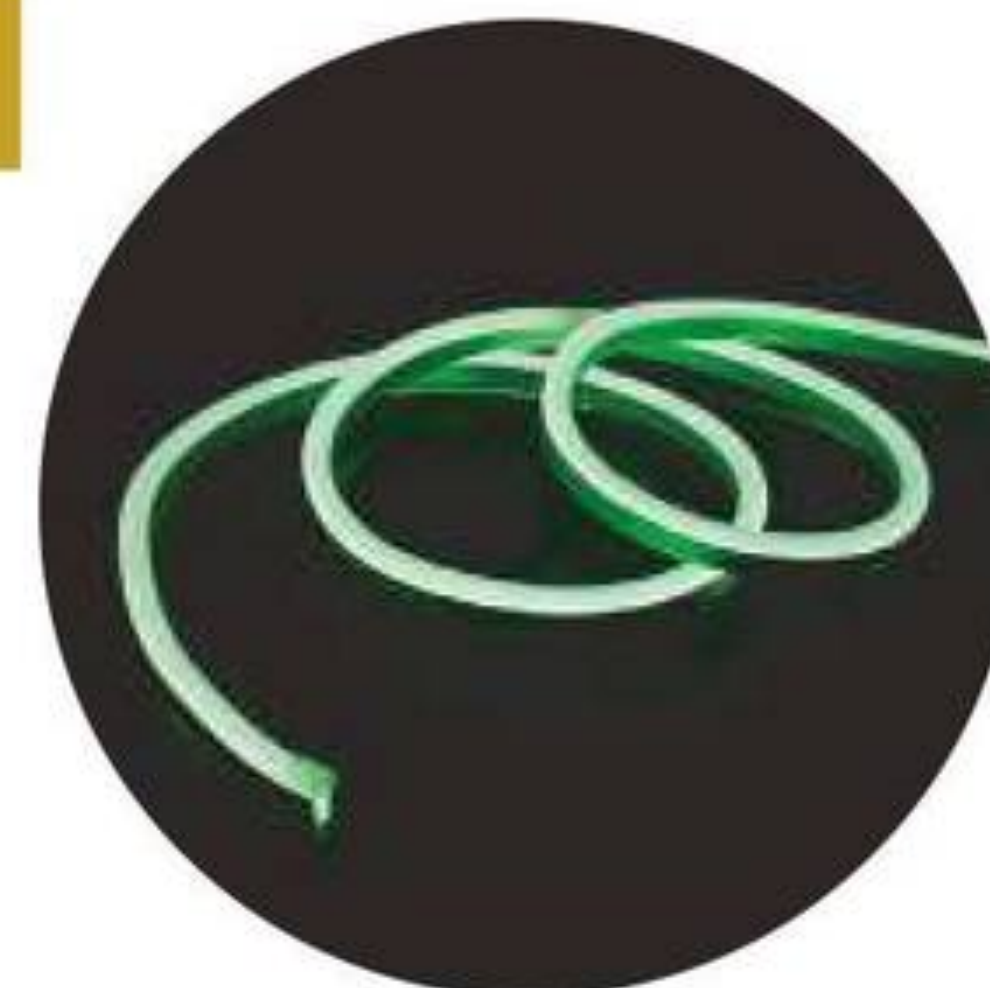

1 x 1.8 cm

10W/m

◦ 57099



◀ Blanco



1 x 1.8 cm

10W/m

• 57100

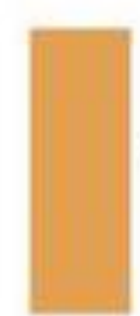

◀ Amarillo



1 x 1.8 cm

10W/m

• 57101



◀ Rojo



1 x 1.8 cm



TECNOLOGÍA
LED



127 V



SMD



IP65



Corte cada
1 m

Carrete de 20 metros
120 LEDs por metro

ACCESORIOS

MONOCROMÁTICAS



57103
Rectificador



57105
Pin



57106
Clip



57104
Tapón
terminal

TIRAS DE COLOR



40W

• 51382



1 x 0.3 cm

40W

• 51383



1 x 0.3 cm

40W

• 51384

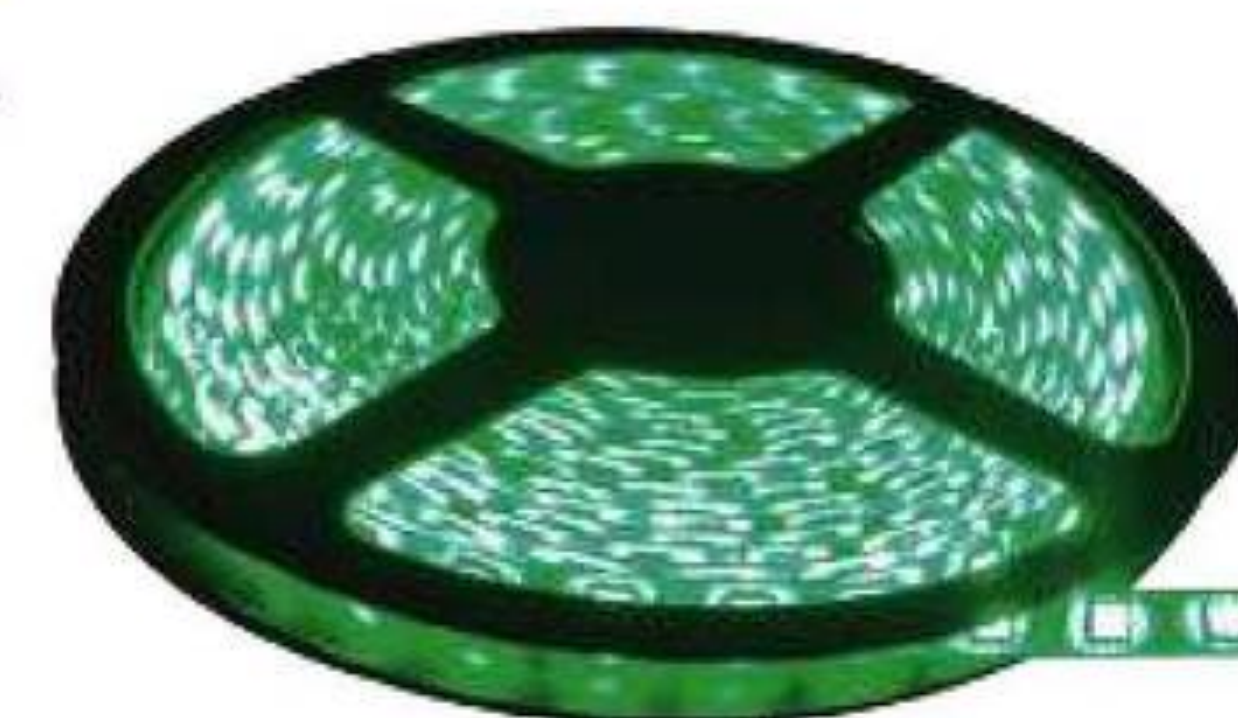

1 x 0.3 cm

40W

• 51385



1 x 0.3 cm

40W

• 51386

RGB



1 x 0.3 cm

Carrete de 5 metros
60 LEDs por metro



100-240 V
12 V



20 000 h

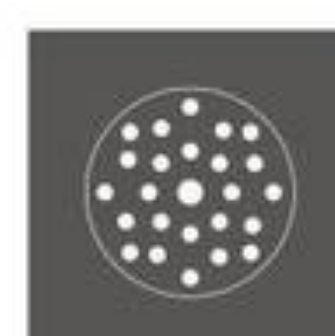

SMD



>70



IP65

TIRAS 120 LEDs POR METRO



Carrete de 5 metros

10W/m

• 51867



720 lm/m



1 x 0.2 cm



51870

Clip Conector Flexible



51868

Clip Conector

10W/m

• 51995 • 51994



720 lm/m



1 x 0.2 cm



51995

Clip Conector Flexible



51996

Clip Conector

DE 60 LEDs por metro Carrete de 5 metros

10W/m

• 51596 • 51597



1 200 lm/m



1 x 0.2 cm



51580

Clip Conector Flexible



51579

Clip Conector

DRIVERS



IP20

150W

51577
Bivoltaje 12 V
90-130 V
185-250 V



200W

51578
100-130 V
220-240 V

100W

51997-1
100-264 V
12 V



IP20



12 V



SMD



>80



IP20





Lámparas

***ALTA INTENSIDAD
DE DESCARGA HID***

Ideal para grandes alturas.

**Aditivos Metálicos
Vapor de Sodio**

ADITIVOS METÁLICOS | OVOIDES



ADITIVOS METÁLICOS

175W

●50281



9.1 x 21.1 cm



14 400 lm



132 V



10 000 h



ED28



M57/E

250W

●50283



9.1 x 21.1 cm



20 000 lm



133 V



10 000 h



ED28



M58/E

400W

●50285



11.8 x 29.2 cm



36 000 lm



135 V



20 000 h



ED37



M59/E

OVOIDE

1 000W

Compacto ●50287



12 x 29.2 cm



110 000 lm



263 V



15 000 h



BT37



M47/E

1 000W

Grande ●50288



12 x 29.2 cm



110 000 lm



263 V



18 000 h



BT56



M47/E



E39



>65



Perfiles de **ALUMINIO**

Imagina, diseña y crea tus espacios favoritos.

PERFILES



ACCESORIOS



57089
Para empotrar
a techo
3.5 x 6.8 cm



51846
Tapa inicial
con agujero



51847
Tapa final
sin agujero



51848
Opresor de barril



51849
Opresor de barril
Techo



51850
Cable de acero 1m



57090
Para suspender
3.5 x 6.8 cm



51839
Tapa inicial con agujero



51840
Tapa final sin agujero



51841
Opresor de barril



51842
Opresor de barril
Techo



51843
Cable de acero 1 m



57091  IP65
Esquinero
para sobreponer
3 x 3 cm



51545
Tapa inicial con agujero



51546
Tapa final sin agujero



51547
Soporte de montaje
para perfil de aluminio.



57092
Para sobreponer
1.3 x 1.9 cm



51562
Tapa inicial con agujero



51563
Tapa final sin agujero



51564
Clip

PERFILES



57093
Para sobreponer
con riel
1.3 x 1.9 cm

ACCESORIOS



51568
Tapa inicial con agujero



51569
Tapa final sin agujero



57094
Para sobreponer
o empotrar a plafón
2.9 x 1 cm



51550
Tapa inicial con agujero



51551
Tapa final sin agujero



51552
Soporte de montaje para
perfil de aluminio.



57095
Para empotrar
a muro
2.4 x 3.5 cm



51532
Tapa inicial con agujero



51533
Tapa final sin agujero



51534
Clip



IP65
57096
Para empotrar
a muro
1.7 x 7 cm



51538
Tapa inicial de silicón
con agujero.



51539
Tapa final de silicón
sin agujero.



51540
Tapa inicial con agujero



51541
Tapa final sin agujero



51542
Clip

PERFILES



ACCESORIOS



57089
Para empotrar
a techo
3.5 x 6.8 cm



51846
Tapa inicial
con agujero



51847
Tapa final
sin agujero



51848
Opresor de barril



51849
Opresor de barril
Techo



51850
Cable de acero 1m



57090
Para suspender
3.5 x 6.8 cm



51839
Tapa inicial con agujero



51840
Tapa final sin agujero



51841
Opresor de barril



51842
Opresor de barril
Techo



51843
Cable de acero 1 m



57091  IP65
Esquinero
para sobreponer
3 x 3 cm



51545
Tapa inicial con agujero



51546
Tapa final sin agujero



51547
Soporte de montaje
para perfil de aluminio.



57092
Para sobreponer
1.3 x 1.9 cm



51562
Tapa inicial con agujero



51563
Tapa final sin agujero



51564
Clip

 **INTERIOR**

 **EXTERIOR**

LÍNEA
**Brilla
Max**

LED

Bulbos

MR16

Lineal T8

Alta Potencia

Downlight

Lámparas Fluorescentes

Decorativos de LED

Reflectores de LED

A prueba de polvo y agua

Luminario Industrial

Luminario Suburbano

BULBOS DE LED



5W

•51935



5.5 x 11 cm



450 lm



127 V

5W

•51509 •51604

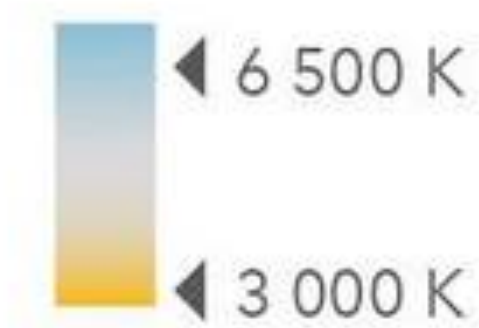

5.5 x 11 cm



350 lm



100-240 V



200°



30 000 h



SMD



E26



>80

DOWNLIGHTS CON BRACKET AJUSTABLE

15W

•57124



17.5 x 17.5 cm



1 100 lm



100-240 V



120°



25 000 h



SMD



>80

ALTA POTENCIA LED

27W

•51670



2 600 lm

9.8 x 18.5 cm



45W

•51672



4 400 lm

12.6 x 24.6 cm

36W

•51671



3 500 lm

11.6 x 21.5 cm



110-240 V



200°



30 000 h



SMD



E26



80

DOWNLIGHTS DE *LED*

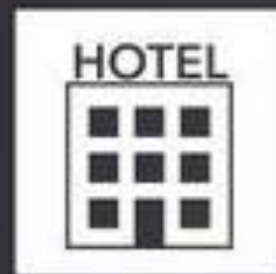

6W

•51592



1.3 x 12 cm



300 lm



9W

•57071



1.5 x 14.5 cm



500 lm



12W

•51593



1.3 x 17 cm



750 lm



18W

•51594



1.3 x 22.5 cm



1 050 lm



SURFACE

18W

•57138



21 x 21 cm



1 200 lm



100-240 V



120°



50 000 h

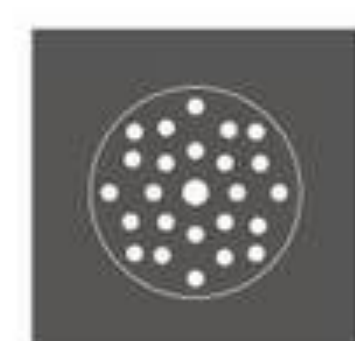

SMD



70



100-240 V



25 000 h



SMD

MR16 DE *LED*



3W

•51606 •51605



5 x 4.5 cm



100-250 V



210 lm



GU5.3

6W

•57180 •51608



5 x 4.5 cm



100-240 V



410 lm



GU5.3

3W

•57064 •57063



5 x 4.5 cm



100-250 V



250 lm



GU10



38°



25 000 h

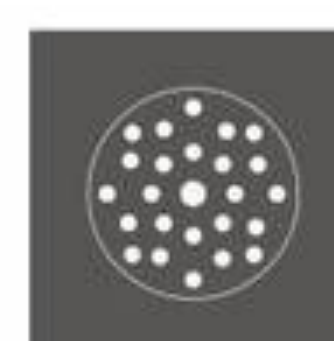

SMD



>80

SPOTS LED PARA RIEL DE 3 VÍAS



15W

•57061



8.1 x 15.6 cm



15W

•57062



8.1 x 15.6 cm



100-265 V



980 lm



24°



25 000 h



COB



>80

DECORATIVO PARA SOBREPONER DE LED

12W

•51503

27 x 8.5 cm



750 lm

18W

•51504

35 x 9.5 cm



1 150 lm



24W

•51505

27 x 8.5 cm



1 500 lm



110-130 V



20 000 h



SMD



>70

REFLECTORES DE *LED*



8W

•57112



10 x 9.4 cm



600 lm



20 000 h

10W

•51486



11.5 x 7.1 cm



630 lm

20W

•57014



12.5 x 10 cm



1 700 lm

30W

•57015



15.6 x 12.3 cm



2 500 lm



110-130 V



120°



50 000 h

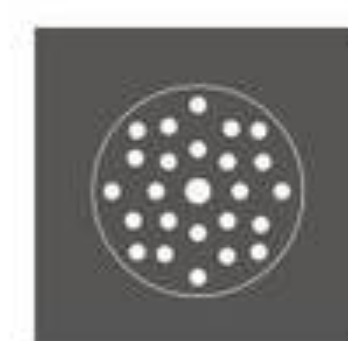

SMD



>80



>0,9



IP65

REFLECTORES DE LED



20W

•57163



12.9 x 11.1 x 3.1 cm



1 800 lm

30W

•57164



15.3 x 13.4 x 3.1 cm



2 800 lm

50W

•57165



19.1 x 16.4 x 3.1 cm



4 600 lm

100W

•57166



25.5 x 21.3 x 3.1 cm



10 000 lm

150W

•57167



36.9 x 32.6 x 3.9 cm



15 000 lm

200W

•57168

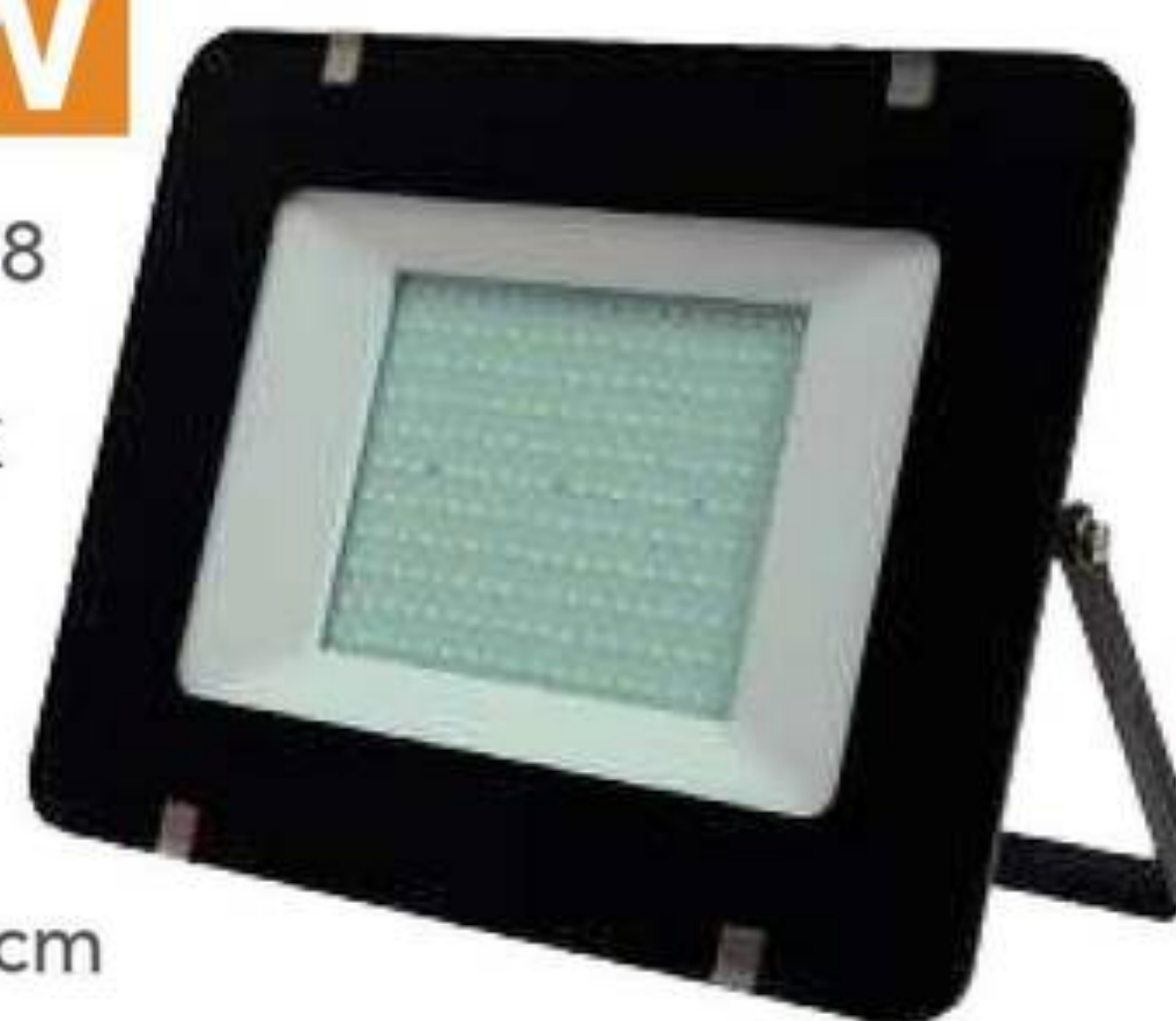

40.5 x 34.4 x 4.3 cm



20 000 lm



100-240 V



120°



25 000 h

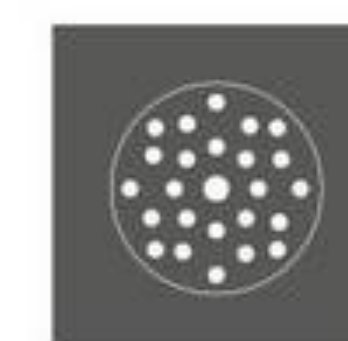

SMD



IP65

LUMINARIO INDUSTRIAL



100W

Bivoltaje

•57082

◀ 6 500 K

28 x 28 cm



8 500 lm



110-130 V
220 V



120°



30 000 h



SMD



>0,9



IP65

TUBO LED

9W

Tubo T8

Vidrio Opalino

•51615

◀ 6 500 K

60 cm



700 lm



100-240 V



220°



25 000 h



G13



70



Conexión
1 lado

LUMINARIO DE LED A PRUEBA DE POLVO Y AGUA

36W

•57118 •51610

◀ 6 500 K

4.4 x 5 x 120 cm



3 500 lm
2 550 lm



100-265 V



25 000 h

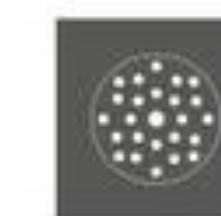

SMD



>80



IP65

TIRAS DE LED



24W

•57073

RGB

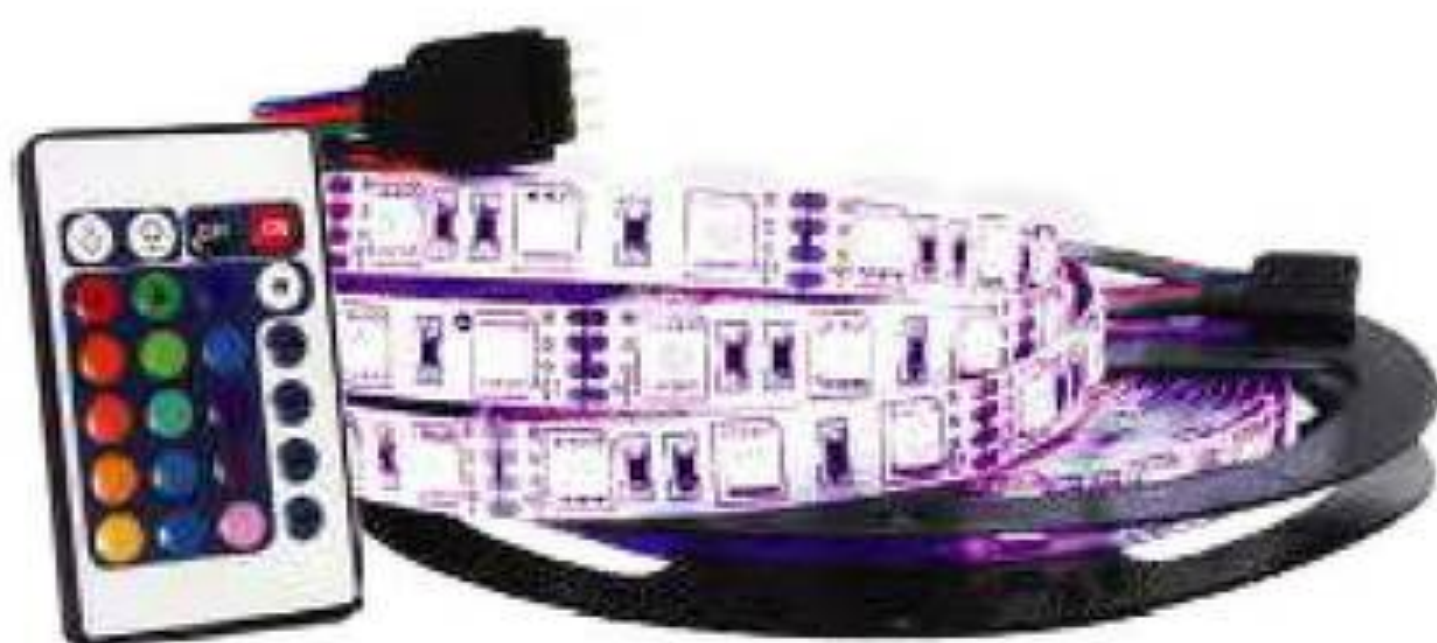

24W

•57074

◀ Rojo

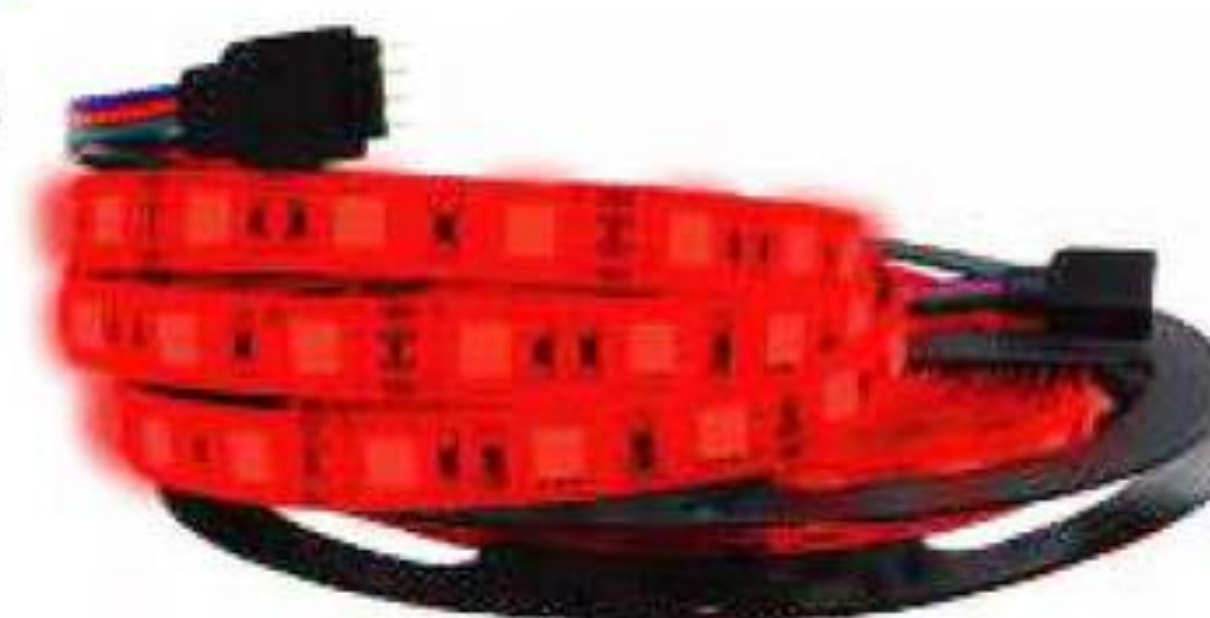

24W

•57074

◀ Verde

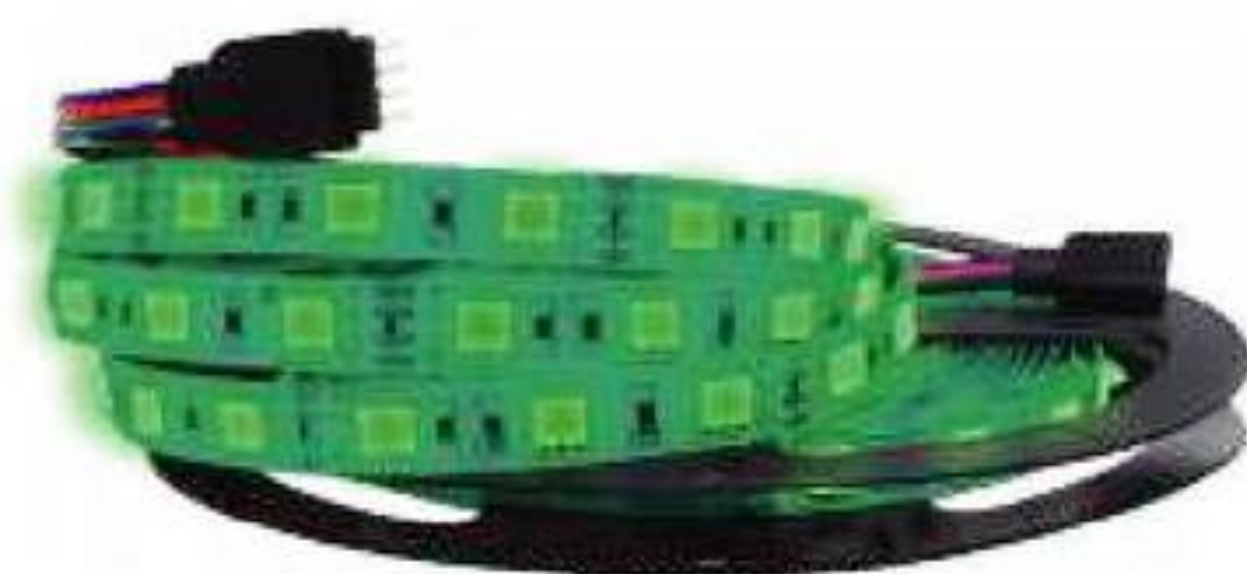

24W

•57076

◀ Azul



24W

•57077

◀ Amarillo



5 Metros

LUMINARIO DE VANIDAD

36W

•57111



49.8 x 2.5 cm



600 lm



110-240 V

300°

30 000 h

>80

IP54

LUMINARIO SUBURBANO



30W

•57001



◀ 6 500 K



30 x 6 x 2.5 cm



2 700 lm



100-130 V



110°



25 000 h

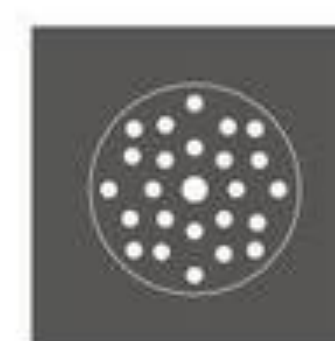

SMD



>80



>0,9



IP65



IK08









GLOSARIO

Índice de protección IP: Es el nivel de protección proporcionado por un envolvente contra el acceso a las partes peligrosas, contra la penetración de cuerpos sólidos extraños y contra la penetración del agua.

El primer carácter indica el grado de protección contra el ingreso de objetos o partículas sólidas externas.

- 1**  Protegido contra objetos de 50 mm de diámetro o mayores.
- 2**  Protegido contra objetos de 12.5 mm de diámetro o mayores.
- 3**  Protegido contra objetos de 2.5 mm de diámetro o mayores.
- 4**  Protegido contra objetos de 1.0 mm de diámetro o mayores.
- 5**  Protegido contra polvo.
- 6**  Completamente protegido contra polvo.

El segundo carácter indica el grado de protección contra el ingreso del agua con defectos dañinos.

- 1**  Protegido contra gotas verticalmente de agua.
- 2**  Protegido contra gotas de agua de hasta 15° con respecto a la vertical.
- 3**  Protegido contra gotas de agua de hasta 60° con respecto a la vertical.
- 4**  Protegido contra proyecciones de agua en todas direcciones.
- 5**  Protegido contra chorros de agua en todas direcciones.
- 6**  Protegido contra fuertes chorros de agua similar a la fuerza de una ola.
- 7**  Protegido contra la inmersión en agua.
- 8**  Protegido contra efecto prolongado a la inmersión del agua bajo presión.



Índice de protección IK: Determina el grado de protección de un material contra los choques de origen mecánico.

1  Energía de impacto: 0.150 J

6  Energía de impacto: 1.00 J

2  Energía de impacto: 0.200 J

7  Energía de impacto: 2.00 J

3  Energía de impacto: 0.350 J

8  Energía de impacto: 2.00 J

4  Energía de impacto: 0.500 J

9  Energía de impacto: 10.00 J

5  Energía de impacto: 0.700 J

10  Energía de impacto: 20.00 J

En aplicaciones:



Residenciales



Oficinas



Centros Comerciales



Restaurantes



Hotelería



Bodegas



Escuelas



Fábricas



Vialidades



Estacionamientos



Jardines



Joyería



Perímetros

Referente a las lámparas y luminarios



Voltaje



Flujo luminoso



Ángulo de apertura



Horas de vida



Atenuable



Diámetro



Índice de Reproducción de Color



Alto Factor de Potencia



Código ANSI



Fuente de luz dirigible



Luz Directa e Indirecta



Luz Directa



Luz Indirecta

Bases:



E12



E14



E26



E39



GU5.3



GU10



G4



G9



G24



G5

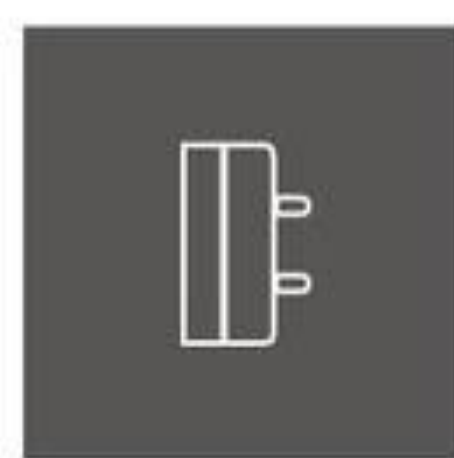

G13



FA8

Temperatura de color:



Tipo de LED:



Referentes a los tubos:



Otros:



Potencia: Unidad utilizada para medir el consumo de energía de la lámpara o sistema. Su unidad de medida es el watt (W).

Flujo luminoso: Es la cantidad de luz emitida por una fuente en distintas direcciones, ésta es percibida por el ojo humano. Su unidad de medida es el lumen (lm).

Índice de Rendimiento de color (IRC): También llamado índice de reproducción cromática, es una medida con la que cuenta una fuente de luz y se refiere a la capacidad que tiene para reproducir fielmente los colores de los objetos que se iluminan. Esto comparándolo con una fuente de luz natural o ideal, la cual se considera el índice máximo (100).



Intensidad Luminosa: Cantidad de luz emitida por una fuente, referida a una determinada dirección, su unidad de medida es la candela (cd).

Iluminancia: La iluminancia o nivel de iluminación se define como el flujo luminoso que incide sobre una superficie. Su unidad de medida es el Lux (lx).

Luminancia: La luminancia se define como la densidad angular y superficial de flujo luminoso que incide, atraviesa o emerge de una superficie siguiendo una dirección determinada. Alternativamente, también se puede definir como la densidad superficial de intensidad luminosa en una dirección dada.

Temperatura de color: Se define comparando su color dentro del espectro luminoso con el de una luz que emitirá un cuerpo negro calentado a una temperatura determinada. Es por ello que la temperatura de color se mide en Kelvin (K), a pesar de no reflejar expresamente una medida de temperatura.

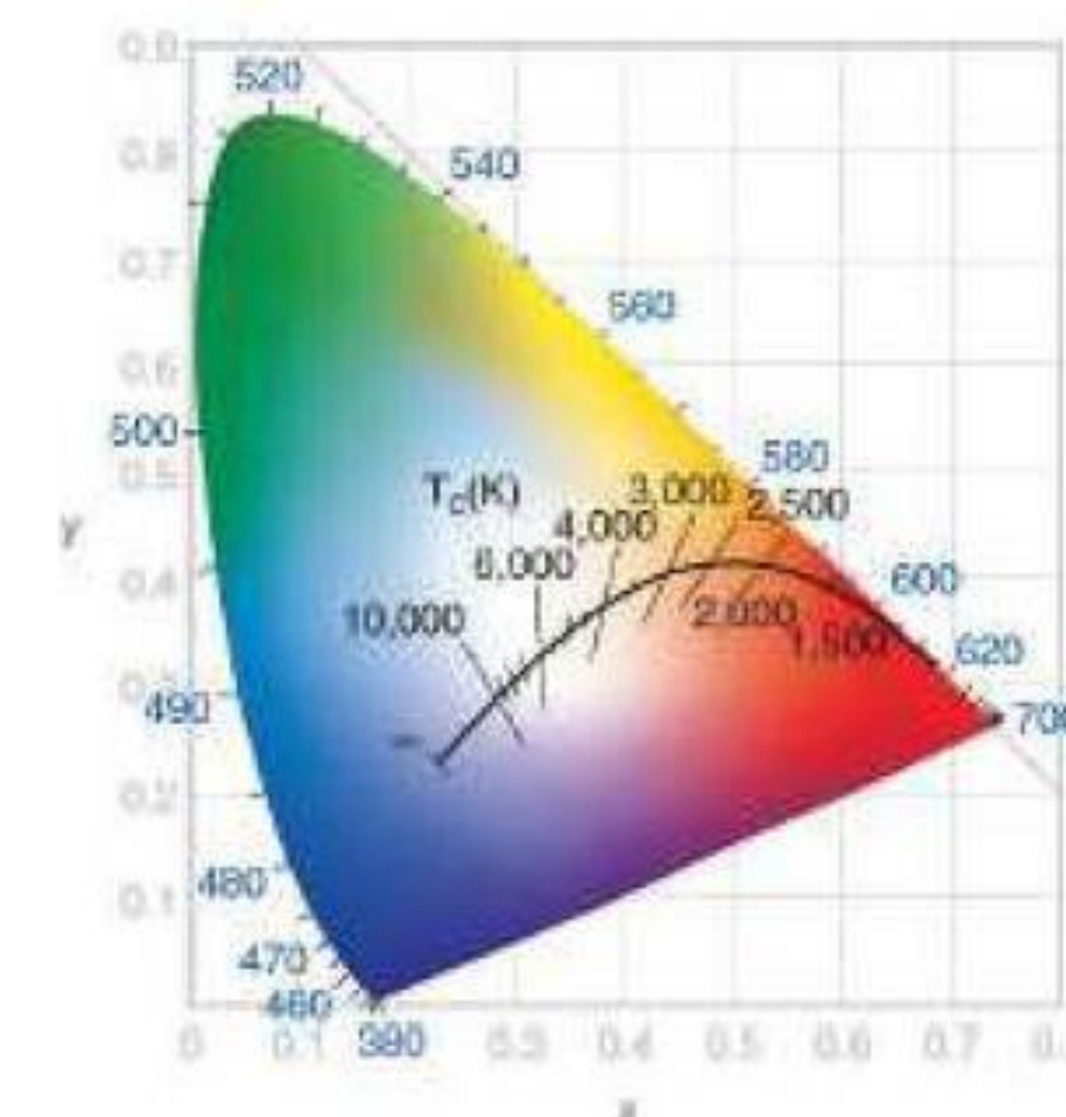

RGB: (Red, Green, Blue) es el concepto que se emplea para referirse a un modelo cromático que consiste en representar distintos colores o tonalidades de luz a partir de la mezcla de estos tres colores primarios en iluminación.



Contacto:

Tel: (55) 4430 4222

conektate@conekta.com.mx

www.conekta.com.mx